



TREASURE  
GARDEN.

*The World's Favorite Shade*

2022



# INTRODUCTION

For over 36 years, Treasure Garden has manufactured the widest selection of shade products in the industry. We offer more than 25,000 variations of shade solutions and accessories. From our state-of-the-art cantilevers to our wide variety of fashion forward market umbrellas, Treasure Garden has a perfect shade solution for your outdoor environment.

Treasure Garden is a one stop shop for our customers. We offer the most comprehensive lines of umbrellas, bases, lights, protective covers, cleaning and maintenance products and outdoor rugs in the industry. Our Shademaker and Jardinico collections offer elegantly designed parasols with robust construction built to last for commercial or residential applications; all from one reliable source.

Our Southern California facility in Baldwin Park, as well as both our state-of-the-art facilities in Ningbo and Qingdao, China, are integral parts of our business operation and point of service. Treasure Garden is a vertically integrated manufacturer. We manufacture and produce over 90% of the components used in our products from their raw state. This allows Treasure Garden the advantage of monitoring every stage of the manufacturing process to maintain a consistent level of quality and delivery.

The 6,000 employees who share in the same vision on a daily basis and their attention to detail enables Treasure Garden to continue to be...

*"The World's Favorite Shade".*





p002

TREASURE GARDEN®  
*The World's Favorite Shade*

p096

shademaker  
architectural shade

p118

jardinico®  
CARACTÈRE

# TABLE OF CONTENTS

## AKZ PLUS CANTILEVER

13' Starlux AKZ Plus	6
13' AKZ Plus	7
10'x13' AKZ Plus	8
11.5' AKZ Plus	9
11' AKZ Plus	10

## AG CANTILEVER

11.5' AG25T	14
10' AG25TSQ	15
11' AG28	16
10' AG19	17

## CANTILEVER BASES

Bases and Mount Kit Options	18-19
-----------------------------	-------

## SPECIALTY

11' Vienna Alu Teak	22
10' Shanghai Collar Tilt	23

## MARKET

9' Starlux Collar Tilt	26
11' Collar Tilt	27
9' Collar Tilt	28
11' Auto Tilt	29
9' Auto Tilt	30
8'x10' Auto Tilt	31
8'x11' Crank Lift	32
9' Glide Tilt	33
7.5' Glide Tilt	34
9' Push Button Tilt	35
7.5' Push Button Tilt	36
9' Quad Pulley Lift	37

## COMMERCIAL

9' Commercial	40
7' Commercial	41

## FABRIC COLLECTION

Fabrics	44-47
Fabric Index	48-49
Fabric Cleaning and Maintenance Instructions	50

## ACCESSORIES

Umbrella Bases	54-58
Umbrella Lights	60-63
Outdoor Rug Collection	64-71

## TG CARE

Protective Furniture Cover Collection	74-79
Care and Maintenance Products	80-81
Replacement Canopy	82-83
Replacement Frames/Bottom Poles	83

## MERCHANDISING

Designer Canopy Collection	86-87
Display Stands/Mini Umbrellas	88-89
Science Behind Shade	90-91

## SALES PROGRAMS

TG Custom	92
TG Direct	93
TGEx Quick-Ship	94
Cantilever Quick-Ship	95

## PRODUCT INFORMATION

Terms & Conditions	134-136
Warranty/Guarantee	137-138





TREASURE  
GARDEN<sup>®</sup>

*The World's Favorite Shade*



## AKZ Plus Cantilever Collection

---

13' Starlux  
AKZ Plus Cantilever  
Octagon Series

13' AKZ Plus Cantilever  
Octagon Series

10'x13' AKZ Plus Cantilever  
Rectangle Series

 11.5' AKZ Plus Cantilever  
Square Series

11' AKZ Plus Cantilever  
Octagon Series

**Shown:**

**Umbrella:**

AKZP13LX-09

6433 Neptune

**Base Option:**

BASE-13R-09

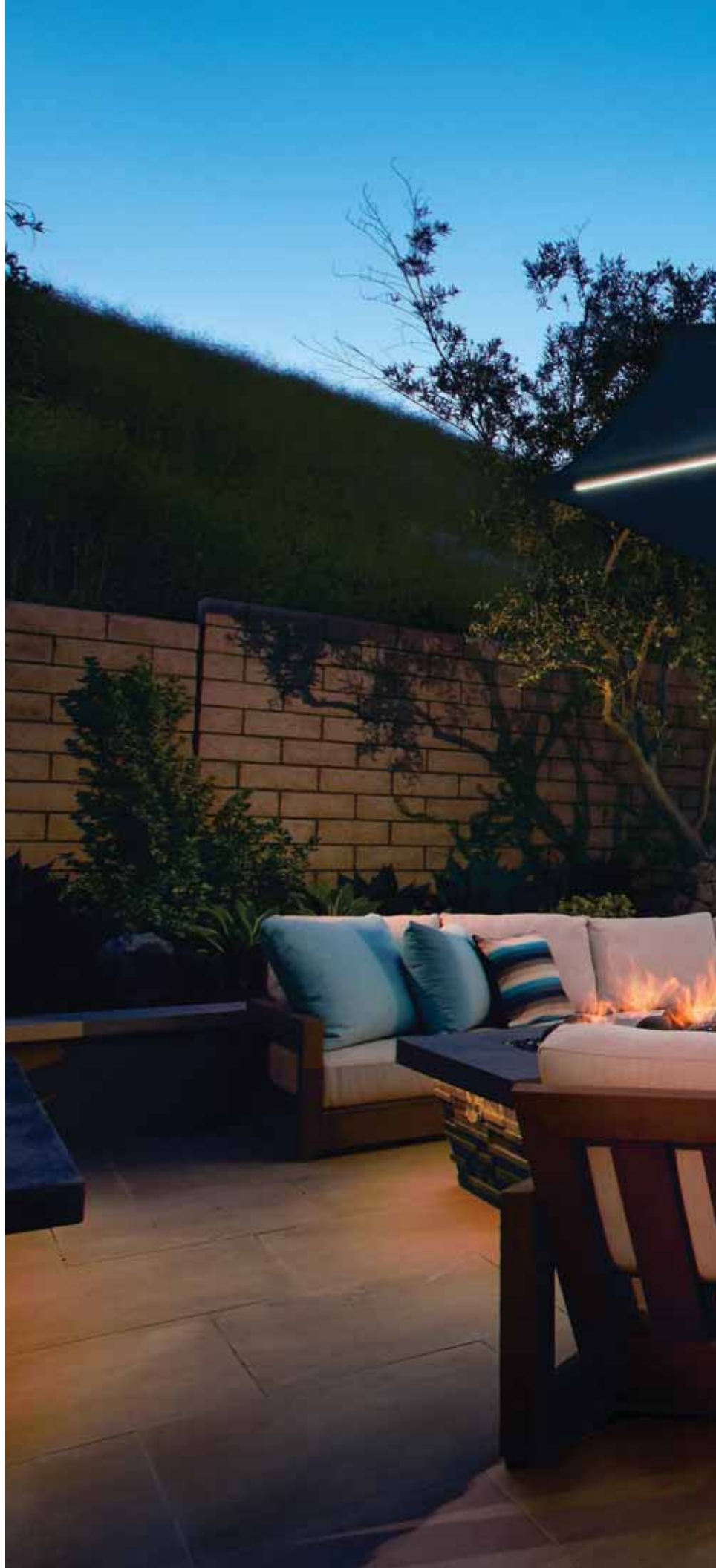





**SHOWN:**

**Item No:** AKZP13LX-00D w/ P-AKZPBATTERY-00 (Battery sold separately)

**Fabric:** 7823 Atlantic Beechwood

**Base:** BASE-13R-00 (Base sold separately)



**OPTIONAL ACCESSORY MSRP**

Starlux AKZ Plus  
Rechargeable Battery Pack **\$375**  
**P-AKZPBATTERY-0\_**



CANTILEVER

**FEATURES**

- › Light strips built into (8) ribs for elegant & modern look
- › (2) Light settings (low/high)
- › 20,000 lifetime hours
- › Powder coated aluminum
- › 100% Kevlar mesh lift cord for added strength and durability
- › Foot pedal to easily rotate umbrella 360°
- › Infinite front to back tilt: Up to 40° back tilt
- › Tilts left and right at: 18°, 36°, and 54° angles
- › Built-in light adapter to fit Treasure Garden lights
- › UL approved 17 ft. power supply cord
- › Includes protective cover

**OPTIONS**

- › Rechargeable Battery Pack (Up to 8 hours of battery life)
- › Valance (Add "V" to item no.)  
Example: **AKZP13LX-00DV**
- › Bases and Mount Kits (pages 18 & 19)

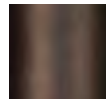

**AKZP13LX-00D**  
Bronze



**AKZP13LX-09D**  
Black

GRADE	DWV	DWV w/ Valance DC9/DC11
A+	<b>\$4,040</b>	<b>\$4,215</b>
A	<b>\$3,105</b>	<b>\$3,335</b>
C / COM †	<b>\$2,415</b>	<b>\$2,580</b>

**NOTE:** Price includes frame and canopy only.

†COM - Customer's Own Material. For COM, see page 139.

**Shipping Information: Truck only**

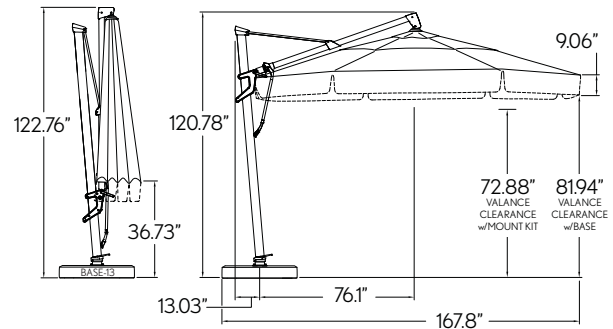

ITEM NO.	Size	Shape	Ribs	Pole Dia.	Vent	Lift	Tilt	Weight	Cube	Minimum Base Wt.
<b>AKZP13LX</b>	13'	Octagon	8	3.64" x 2.56"	DWV	Crank	Front to Back Left to Right	DWV 108 lbs. DWV-V 109 lbs.	12	400 lbs.





**SHOWN:**  
**Item No:** AKZP13-02D  
**Fabric:** 6902 Bedrock Smoke  
**Base:** BASE-13R-02 (Base sold separately)



**FEATURES**

- › Powder coated aluminum
- › 100% Kevlar mesh lift cord for added strength and durability
- › Foot pedal to easily rotate umbrella 360°
- › Infinite front to back tilt: Up to 40° back tilt
- › Tilts left and right at: 18°, 36°, and 54° angles
- › Built-in light adapter to fit Treasure Garden lights
- › Includes protective cover

**OPTIONS**

- › Valance (Add "V" to item no.) - Example: **AKZP13-00DV**
- › Bases and Mount Kits (pages 18 & 19)

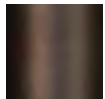

**AKZP13-00D**  
Bronze



**AKZP13-02D**  
Anthracite



**AKZP13-09D**  
Black

GRADE	DWV	DWV w/ Valance DC9/DC11
A+	<b>\$3,465</b>	<b>\$3,615</b>
A	<b>\$2,655</b>	<b>\$2,850</b>
C / COM †	<b>\$2,070</b>	<b>\$2,215</b>

**NOTE:** Price includes frame and canopy only.  
 †COM - Customer's Own Material. For COM, see page 139.  
**Shipping Information: Truck only**

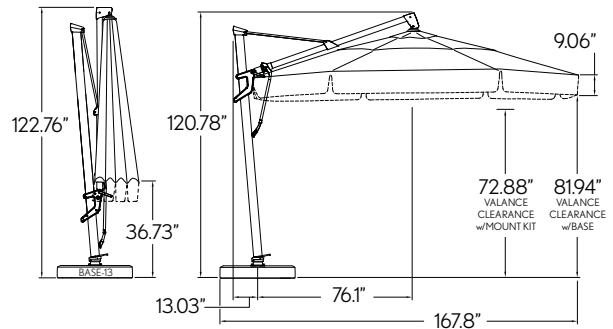

ITEM NO.	Size	Shape	Ribs	Pole Dia.	Vent	Lift	Tilt	Weight	Cube	Minimum Base Wt.
<b>AKZP13</b>	13'	Octagon	8	3.64" x 2.56"	DWV	Crank	Front to Back Left to Right	DWV 104 lbs. DWV-V 105 lbs.	12	400 lbs.



**SHOWN:**

**Item No:** AKZPRT-00  
**Fabric:** 5417 Tuscan  
**Base:** BASE-13R-00 (Base sold separately)



CANTILEVER

**FEATURES**

- › Powder coated aluminum
- › 100% Kevlar mesh lift cord for added strength and durability
- › Foot pedal to easily rotate umbrella 360°
- › Infinite front to back tilt: Up to 40° back tilt
- › Tilts left and right at: 18°, 36°, and 54° angles
- › Built-in light adapter to fit Treasure Garden lights
- › Includes protective cover

7823, 7824 AND STRIPED FABRICS NOT AVAILABLE ON THIS STYLE.

**OPTIONS**

- › Bases and Mount Kits (pages 18 & 19)



**AKZPRT-00**  
Bronze



**AKZPRT-02**  
Anthracite



**AKZPRT-09**  
Black

**GRADE**

**SWV**

A+	<b>\$3,440</b>
A	<b>\$2,650</b>
C / COM †	<b>\$2,065</b>

**NOTE:** Price includes frame and canopy only.  
 †COM - Customer's Own Material. For COM, see page 139.  
**Shipping Information: Truck only**

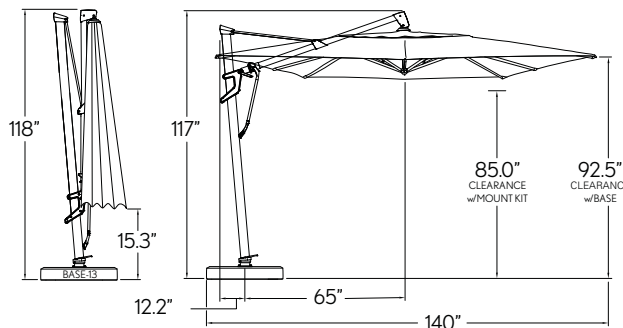

ITEM NO.	Size	Shape	Ribs	Pole Dia.	Vent	Lift	Tilt	Weight	Cube	Minimum Base Wt.
<b>AKZPRT</b>	10'x13'	Rectangle	8	3.64" x 2.56"	SWV	Crank	Front to Back Left to Right	104 lbs.	11	400 lbs.



**SHOWN:**

**Item No:** AKZPSQ11-09  
**Fabric:** 48103S Cast Ocean  
**Base:** BASE-13R-09 (Base sold separately)



**FEATURES**

- › Powder coated aluminum
- › 100% Kevlar mesh lift cord for added strength and durability
- › Foot pedal to easily rotate umbrella 360°
- › Infinite front to back tilt: Up to 40° back tilt
- › Tilts left and right at: 18°, 36°, and 54° angles
- › Built-in light adapter to fit Treasure Garden lights
- › Includes protective cover

**7823 & 7824 FABRICS NOT AVAILABLE ON THIS STYLE.**

**OPTIONS**

- › Valance (Add "V" to item no.) - Example: **AKZPSQ11-00V**
- › Bases and Mount Kits (pages 18 & 19)

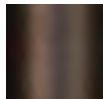

**AKZPSQ11-00**  
Bronze



**AKZPSQ11-09**  
Black

GRADE	SWV	SWV w/ Valance
A+	<b>\$3,320</b>	<b>\$3,725</b>
A	<b>\$2,595</b>	<b>\$2,780</b>
C / COM †	<b>\$2,045</b>	<b>\$2,130</b>

**NOTE:** Price includes frame and canopy only.  
 †COM - Customer's Own Material. For COM, see page 139.  
**Shipping Information: Truck only**

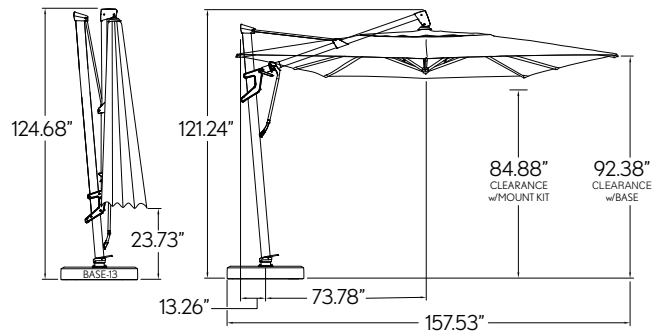

ITEM NO.	Size	Shape	Ribs	Pole Dia.	Vent	Lift	Tilt	Weight	Cube	Minimum Base Wt.
<b>AKZPSQ11</b>	11.5'	Square	8	3.64" x 2.56"	SWV	Crank	Front to Back Left to Right	SWV 89 lbs. SWV-V 90 lbs.	11.52	400 lbs.



**SHOWN:**

**Item No:** AKZP-09D

**Fabric:** DC11 Style - 54048 Charcoal / 6664 Churchill Beach Stripe

**Base:** BASE-13R-09 (Base sold separately)



**FEATURES**

- › Powder coated aluminum
- › 100% Kevlar mesh lift cord for added strength and durability
- › Foot pedal to easily rotate umbrella 360°
- › Infinite front to back tilt: Up to 40° back tilt
- › Tilts left and right at: 18°, 36°, and 54° angles
- › Built-in light adapter to fit Treasure Garden lights
- › Includes protective cover

**OPTIONS**

- › Valance (Add "V" to item no.) - Example: **AKZP-00DV**
- › Bases and Mount Kits (pages 18 & 19)

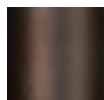

**AKZP-00D**  
Bronze



**AKZP-02D**  
Anthracite



**AKZP-09D**  
Black

**GRADE**

**DWV**

**DWV w/ Valance  
DC9/DC11**

A+	<b>\$3,035</b>	<b>\$3,165</b>
A	<b>\$2,400</b>	<b>\$2,550</b>
C / COM †	<b>\$1,920</b>	<b>\$2,010</b>

**NOTE:** Price includes frame and canopy only.

†COM - Customer's Own Material. For COM, see page 139.

Shipping Information: **Truck only**

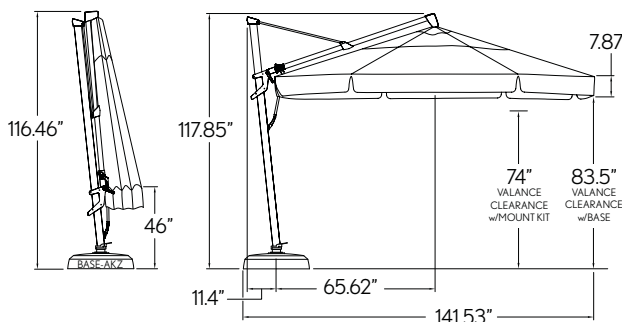

ITEM NO.	Size	Shape	Ribs	Pole Dia.	Vent	Lift	Tilt	Weight	Cube	Minimum Base Wt.
<b>AKZP</b>	11'	Octagon	8	3.64" x 2.56"	DWV	Crank	Front to Back Left to Right	DWV 99 lbs. DWV-V 100 lbs.	10.9	200 lbs.



**Shown:**

**Umbrella:**  
AKZP-00D

56079 Milano Char Stripe

**Base:**

BASE-13R-00

## AG Cantilever Collection

---

11.5' AG25T Cantilever  
Octagon Series

10' AG25TSQ Cantilever  
Square Series

11' AG28 Cantilever  
Octagon Series

10' AG19 Cantilever  
Octagon Series

**Shown:**

**Umbrella:**

AG28RK-03D

6666 Paddock Aqua Stripe

**Base Option:**

BASE-AGRK-02







**SHOWN:**

**Item No:** AG25TR-00D  
**Fabric:** 7822 Mosaic Tile  
**Base:** BASE-13R-00 (Base sold separately)



CANTILEVER

**FEATURES**

- › Powder coated aluminum
- › Foot pedal to easily rotate umbrella 360°
- › Infinite front to back tilt: Up to 30° back tilt
- › Infinite left to right tilting capabilities
- › Built-in light adapter to fit Treasure Garden lights
- › Includes protective cover

**OPTIONS**

- › Valance (Add "V" to item no.) - Example: **AG25TR-00DV**
- › Bases and Mount Kits (pages 18 & 19)

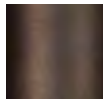

**AG25TR-00D**  
Bronze



**AG25TR-09D**  
Black

**GRADE DWV DWV w/ Valance**

A+	<b>\$2,535</b>	<b>\$2,740</b>
A	<b>\$2,020</b>	<b>\$2,265</b>
C / COM †	<b>\$1,580</b>	<b>\$1,705</b>

**NOTE:** Price includes frame and canopy only.

†COM - Customer's Own Material. For COM, see page 139.

**Shipping Information: Truck only**

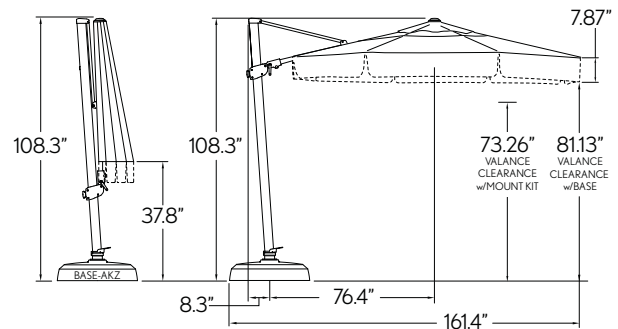

ITEM NO.	Size	Shape	Ribs	Pole Dia.	Vent	Lift	Tilt	Weight	Cube	Minimum Base Wt.
<b>AG25TR</b>	11.5'	Octagon	8	3.54" x 2.56"	DWV	Crank	Front to Back Left to Right	DWV 72 lbs. DWV-V 73 lbs.	7.2	200 lbs.





**SHOWN:**

**Item No:** AG25TSQR-09  
**Fabric:** 48135-10 Bliss Pebble  
**Base:** BASE-13R-09 (Base sold separately)



CANTILEVER

**FEATURES**

- › Powder coated aluminum
- › Foot pedal to easily rotate umbrella 360°
- › Infinite front to back tilt: Up to 30° back tilt
- › Infinite left to right tilting capabilities
- › Built-in light adapter to fit Treasure Garden lights
- › Includes protective cover

**7823 & 7824 FABRICS NOT AVAILABLE ON THIS STYLE.**

**OPTIONS**

- › Valance (Add "V" to item no.) - Example: **AG25TSQR-00V**
- › Bases and Mount Kits (pages 18 & 19)

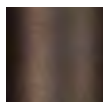

**AG25TSQR-00**  
Bronze



**AG25TSQR-09**  
Black

GRADE	SWV	SWV w/ Valance
A+	<b>\$2,410</b>	<b>\$2,610</b>
A	<b>\$1,930</b>	<b>\$2,140</b>
C / COM †	<b>\$1,525</b>	<b>\$1,685</b>

**NOTE:** Price includes frame and canopy only.

†COM - Customer's Own Material. For COM, see page 139.

Shipping Information: **Truck only**

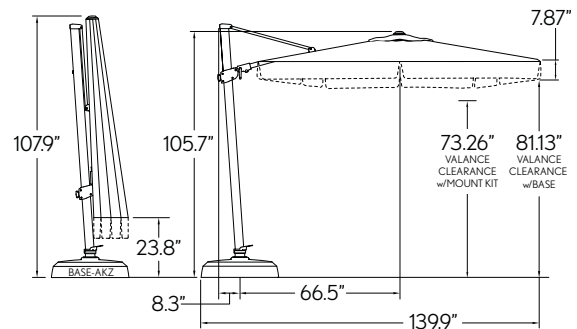

ITEM NO.	Size	Shape	Ribs	Pole Dia.	Vent	Lift	Tilt	Weight	Cube	Minimum Base Wt.
<b>AG25TSQR</b>	10'	Square	8	3.54" x 2.56"	SWV	Crank	Front to Back Left to Right	SWV 72 lbs. SWV-V 73 lbs.	7.2	200 lbs.



**SHOWN:**

**Item No:** AG28RK-03DV

**Fabric:** DC9 Style - 4813 Spa / 48913 Vancouver Coast Stripe

**Base:** BASE-AGRK-02 (Base sold separately)



CANTILEVER

**FEATURES**

- › Powder coated aluminum
- › 100% Kevlar mesh lift cord for added strength and durability
- › A full 360° rotation with (12) 30° locking positions
- › Locking rotation knob
- › Infinite front to back tilt: Up to 40° back tilt
- › Built-in light adapter to fit Treasure Garden lights
- › Includes protective cover

**OPTIONS**

- › Valance (Add "V" to item no.) - Example: **AG28RK-00DV**
- › Base (page 18)



**AG28RK-00D**  
Bronze



**AG28RK-03D**  
White

GRADE	DWV	DWV w/ Valance DC9/DC11
A+	<b>\$2,360</b>	<b>\$2,520</b>
A	<b>\$1,690</b>	<b>\$1,885</b>
C / COM †	<b>\$1,375</b>	<b>\$1,475</b>

**NOTE:** Price includes frame and canopy only.

†COM - Customer's Own Material. For COM, see page 139.

Shipping Information: **Truck only**

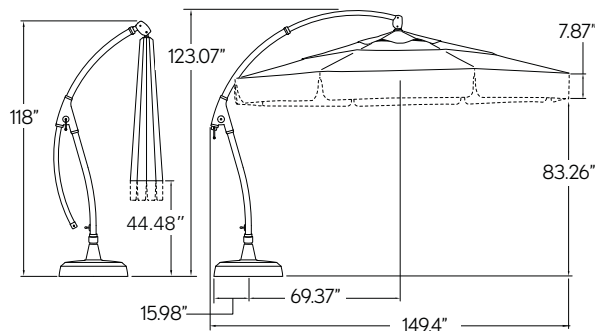

ITEM NO.	Size	Shape	Ribs	Pole Dia.	Vent	Lift	Tilt	Weight	Cube	Minimum Base Wt.
<b>AG28RK</b>	11'	Octagon	8	2.75"	DWV	Crank	Front to Back Left to Right	DWV 74 lbs. DWV-V 75 lbs.	12.5	200 lbs.



**SHOWN:**

**Item No:** AG19-00

**Fabric:** 6463 Reseda

**Base:** BF10-00 Resin Base Weights (Base sold separately)



CANTILEVER

**FEATURES**

- › Powder coated aluminum
- › A full 360° rotation with base stem clamp
- › Tilts left & right: 5 adjustable positions - 18° each position, up to 90°
- › AG universal cross bar stand (included) adjusts to fit 16" to 20" paver sizes
- › Built-in light adapter to fit Treasure Garden lights

**OPTIONS**

- › Base weights (page 18)



**AG19-00**  
Bronze



**AG19-09**  
Black

**GRADE**

**SWV**

A+ **\$1,575**

A **\$1,245**

C / COM † **\$890**

**NOTE:** Price includes frame and canopy only.

†COM - Customer's Own Material. For COM, see page 139.

**Shipping Information: Standard Parcel**

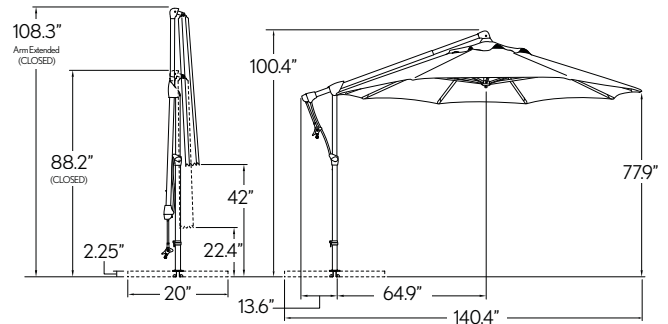

ITEM NO.	Size	Shape	Ribs	Pole Dia.	Vent	Lift	Tilt	Weight	Cube	Minimum Base Wt.
<b>AG19</b>	10'	Octagon	8	2.7"	SWV	Crank	Left to Right	55 lbs.	5.3	180 lbs.

# BASE OPTIONS | Cantilever Series

## AKZ13 Rolling Base      BASE-13R-0\_

Includes: Base frame, lid, foot pedal, (4) wheels and (4) add-on weights to be filled with 230 lbs. of sand and water (sand not included).

Finishes	Size	Weight	Cube	MSRP
0-Bronze 2-Anthracite 9-Black	34" x 34" x 7.5"	190 lbs.	12.56	<b>\$1,275</b>



Compatible with:  
AKZP13LX, AKZP13,  
AKZPRT, AKZPSQ11,  
AKZP, AG25T,  
AG25TSQ

## AKZ13 Base      BASE-13-0\_

Includes: Base frame, lid, and four (4) add-on weights. Base holds up to 400 lbs. of sand (sand not included).

Finishes	Size	Weight	Cube	MSRP
0-Bronze 2-Anthracite 9-Black	34" x 34" x 7.5"	74 lbs.	7	<b>\$555</b>



Compatible with:  
AKZP13LX, AKZP13,  
AKZPRT, AKZPSQ11,  
AKZP, AG25T,  
AG25TSQ

## AKZ Base      BASE-AKZ-0\_

Includes: Base shell and lid. Base holds up to 200 lbs. of sand (sand not included).

Finishes	Size	Weight	Cube	MSRP
0-Bronze 2-Anthracite 9-Black	32" x 32" x 7.5"	38 lbs.	5.5	<b>\$300</b>



Compatible with:  
AKZP  
AG25T  
AG25TSQ

## AG Base      BASE-AGRK-0\_

Includes: Base shell and lid. Base holds up to 200 lbs. of sand (sand not included).

Finishes	Size	Weight	Cube	MSRP
0-Bronze 2-Anthracite	32" x 32" x 7.5"	44 lbs.	6.13	<b>\$360</b>



Compatible with:  
AG28RK

## Resin Base Weights      BF10-0\_

Includes: Four (4) sections that fit onto the AG Universal Cross Bar Stand (included w/frame). Base weights hold up to 220 lbs. of sand (sand not included).

Finishes	Size	Weight	Cube	MSRP
0-Bronze 9-Black	39.4" x 39.4" x 4.5"	29 lbs.	4.7	<b>\$230</b>



Compatible with:  
AG19

## BX Cross Base Weights      BX-AG-0\_

Use four (4) cross base weight sections that conveniently sit into the AG Universal Cross Bar Stand (included w/frame). Four (4) sections required.

Finishes	Size	Weight	Cube	MSRP
0-Bronze 9-Black	19" x 19" x 2"	50 lbs. each	0.67	<b>\$170 per section</b>



Compatible with:  
AG19



Our Mount Kit options open up a world of opportunities for large shades. Kits can be mounted 3 ways - Concrete, In-Ground and Wood Decks.

Compatible with: AKZP13LX, AKZP13, AKZPRT, AKZPSQ11, AKZP, AG25T & AG25TSQ

(MOUNT KITS REDUCES THE CANOPY CLEARANCE BY 7.5")



**Concrete Mount**



**In-Ground Mount**



**Wood Mount**

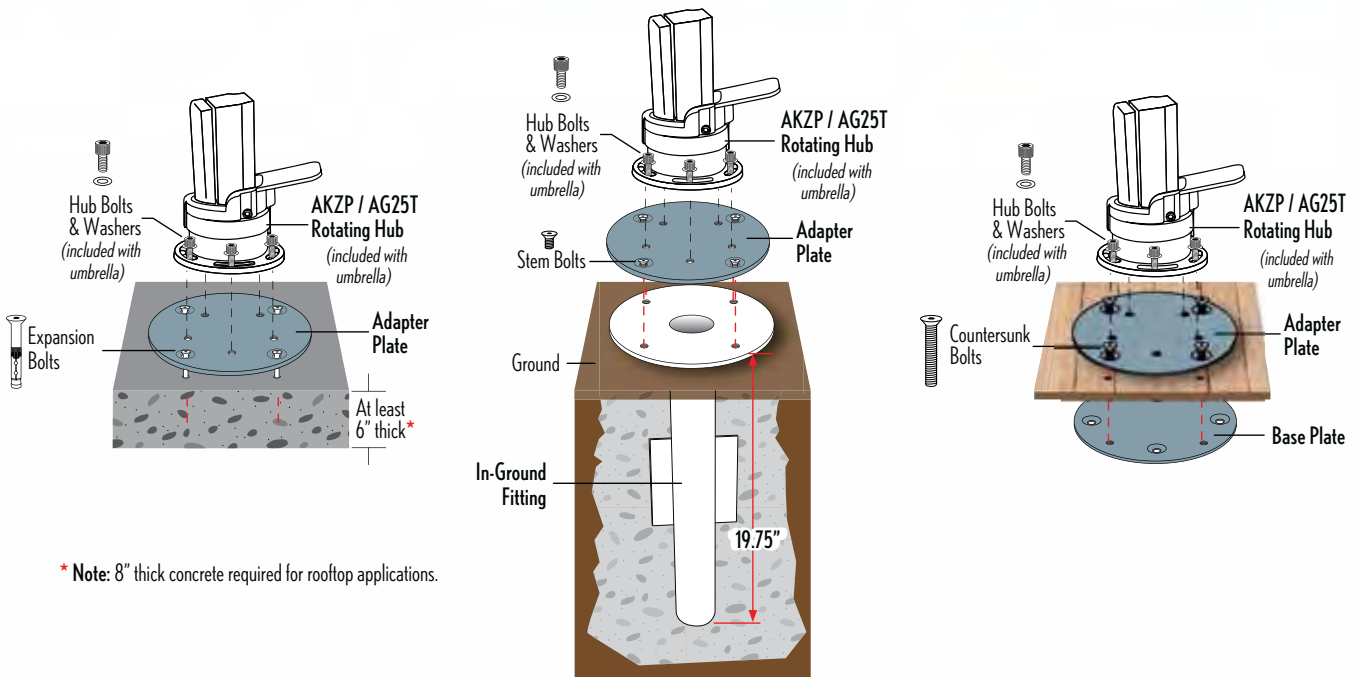

\* Note: 8" thick concrete required for rooftop applications.

Mount Kits		Diameter	Overall Depth	Weight	Cube	Case Pack	Case Weight	Case Cube	MSRP
Concrete Mount Kit	<b>AMK-C22</b>	8.5"	n/a	10 lbs.	0.22	5	49 lbs.	1.1	<b>\$215</b>
In-Ground Mount Kit	<b>AMK-G</b>	8.5"	19.75"	22 lbs.	1.51	4	81 lbs.	6.03	<b>\$170</b>
Wood Mount Kit	<b>AMK-W</b>	8.5"	n/a	14 lbs.	0.22	5	71 lbs.	1.1	<b>\$140</b>

**DISCLAIMER:** The mount kit should only be professionally installed by a licensed contractor. Treasure Garden® assumes no liability and expressly disclaims any responsibility for injuries or damages arising from or related to the failure of buyer to have the mount kit installed by a licensed professional contractor. Treasure Garden makes no warranty except as expressly stated herein, and no warranty except Title to Materials furnished shall be implied with respect to this order.

**DISCLAIMER OF WARRANTIES:** Except as herein expressly set forth, this product is sold "as is" and "with all faults", and without any implied warranty of merchantability -- which warranty is hereby expressly excluded. This product is sold without any implied warranty of fitness for a particular purpose -- which warranty is hereby expressly excluded. Moreover, there are no warranties which extend beyond the description on the face hereof.

CANTILEVER

## Specialty Collection

---

11' Vienna Alu Teak  
Octagon Series

10' Shanghai Collar Tilt  
Round Series



**Shown:**

**Umbrella:**

USA459

6407 Aquatic

**Base Option:**

BKM1009





**SHOWN:**

**Item No:** UV89115AT  
**Fabric:** 5404 Natural / Trim - 54048 Charcoal  
**Base:** BKM1005T/BT2-5T (Base/Stem sold separately)



SPECIALTY

**FEATURES**

- › Mirrored anodized center pole
- › Alu Teak ribs
- › Double pulley lift system
- › Aluminum alloy locking pin



UV89115AT (w/ TRIM option)  
 UV89115A (w/o TRIM option)  
 Mirrored Anodized

**GRADE**

**SWV**

A+	<b>\$1,790</b>
A	<b>\$1,655</b>
C / COM †	<b>\$1,290</b>

**NOTE:** Price includes frame and canopy only.

†COM - Customer's Own Material. For COM, see page 139.

Shipping Information: **Standard Parcel/Courier Services. Oversized - Additional shipping costs for this style.**

**OPTIONS**

Available in all stocked fabrics without trim as well as the 6 set trim combinations shown below:



<b>MAIN: 5403</b> Jockey Red	<b>5404</b> Natural	<b>5422</b> Antique Beige	<b>5439</b> Navy	<b>6407</b> Aquatic	<b>40433</b> Cast Silver
<b>TRIM: 5404 Natural</b>	<b>54048 Charcoal</b>	<b>5404 Natural</b>	<b>5404 Natural</b>	<b>5404 Natural</b>	<b>54048 Charcoal</b>

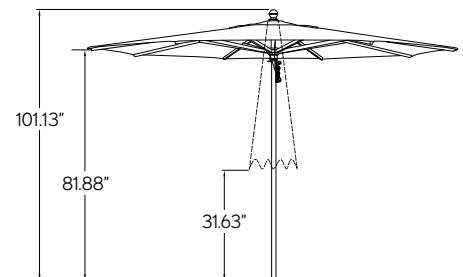

ITEM NO.	Size	Shape	Ribs	Pole Dia.	Vent	Lift	Tilt	Weight	Cube	Minimum Base Wt.
<b>UV89115A</b>	11'	Octagon	8	1.89"	SWV	Double Pulley	n/a	34 lbs.	4.9	100 lbs.





**SHOWN:**  
**Item No:** USA459  
**Fabric:** 6901 Bedrock Sky  
**Base:** BKM1009 (Base sold separately)



**FEATURES**

- › 24 fiberglass ribs
- › Powder coated aluminum
- › Easy to twist collar tilt function
- › Textured two-piece ribbed pole
- › Fabric wrapped finial

**STRIPED FABRICS NOT AVAILABLE ON THIS STYLE.**

**OPTIONS**

- › Bottom pole also available in 36" and 45" (page 83)



**USA459**  
Black

**GRADE**

A+	<b>\$1,205</b>
A	<b>\$995</b>
C	<b>\$790</b>

**NOTE:** Price includes frame and canopy only.  
 Shipping Information: **Standard Parcel/Courier Services**

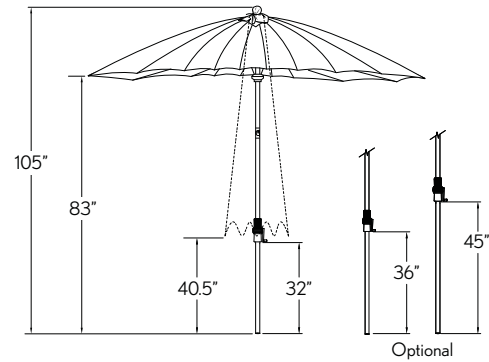

ITEM NO.	Size	Shape	Ribs	Pole Dia.	Bottom Pole	Lift	Tilt	Weight	Cube	Minimum Base Wt.
<b>USA459</b>	10'	Round	24	1.5"	32"	Crank	Collar	25 lbs.	2	80 lbs.

**SPECIALTY**

## Market Collection

---

**9' Starlux Collar Tilt**  
Octagon Series

**11' Collar Tilt**  
Octagon Series

**9' Collar Tilt**  
Octagon Series

**11' Auto Tilt**  
Octagon Series

**9' Auto Tilt**  
Octagon Series

**8'x10' Auto Tilt**  
Rectangle Series

**8'x11' Crank Lift**  
Rectangle Series

**9' Glide Tilt**  
Octagon Series

**7.5' Glide Tilt**  
Octagon Series

**9' Push Button Tilt**  
Octagon Series

**7.5' Push Button Tilt**  
Octagon Series

**9' Quad Pulley Lift**  
Octagon Series

**Shown:**

**Umbrella:**

UM9700

40584-01 Surround Dusk Stripe

**Accessory:**

Antibes Wine Tub

JCA-ANT-WTB



**CAUTION:** Inside pool use, salt & chlorides can accumulate on the powder coat finish, leading to finish failure.





**SHOWN:**  
**Item No:** UM8000LX  
**Fabric:** 5413 Spa  
**Base:** BG500 (Base sold separately)



**FEATURES**

- › Light strips built into (8) ribs for an elegant & modern look
- › External rechargeable battery pack w/ charge level indicator (included)
- › Built-in USB charging port (5V output)
- › Up to 8 hours of battery life
- › 20,000 lifetime hours
- › Powder coated aluminum
- › Easy to twist collar tilt function
- › Textured two-piece ribbed pole
- › Crank lift system
- › 26.5' power supply cord
- › Water and dust resistant

**OPTIONS**

- › Bottom pole also available in 45" (page 83)



UM8000LX  
Bronze



UM8009LX  
Black

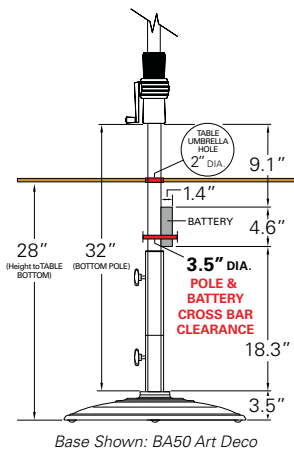

**GRADE**

**SWV**

**DWV / DC**

A+	<b>\$1,200</b>	<b>\$1,265</b>
A	<b>\$1,085</b>	<b>\$1,125</b>
C / COM †	<b>\$915</b>	<b>\$945</b>

**NOTE:** Price includes frame, canopy and rechargeable battery pack.  
 †COM - Customer's Own Material. For COM, see page 139.  
 Shipping Information: **Standard Parcel/Courier Services**

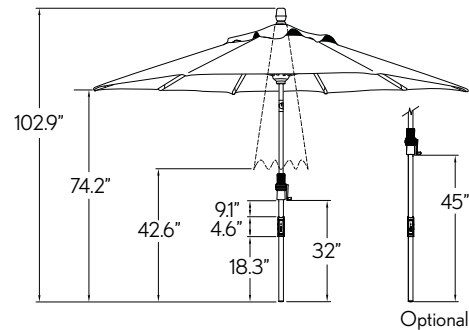

Optional

ITEM NO.	Size	Shape	Ribs	Pole Dia.	Bottom Pole	Vents	Lift	Tilt	Weight	Cube	Minimum Base Wt.
<b>UM800_LX</b>	9'	Octagon	8	1.5"	32"	SWV DWV	Crank	Collar	SWV 24 lbs. DWV 25 lbs.	2.7	50 lbs.



**SHOWN:**  
**Item No:** UM8019  
**Fabric:** 6670 Reliant Coast Stripe  
**Base:** BA509/BW30 (Base/base weight sold separately)



MARKET

**FEATURES**

- › Powder coated aluminum
- › Easy to twist collar tilt function
- › Textured two-piece ribbed pole
- › Crank lift system

**OPTIONS**

- › Bottom pole also available in 45" (page 83)

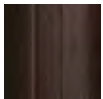

**UM8010**  
Bronze



**UM8019**  
Black

GRADE	SWV	DWV / DC
A+	<b>\$1,155</b>	<b>\$1,235</b>
A	<b>\$950</b>	<b>\$1,020</b>
C / COM †	<b>\$765</b>	<b>\$820</b>

**NOTE:** Price includes frame and canopy only.  
 †COM - Customer's Own Material. For COM, see page 139.  
 Shipping Information: **Standard Parcel/Courier Services**

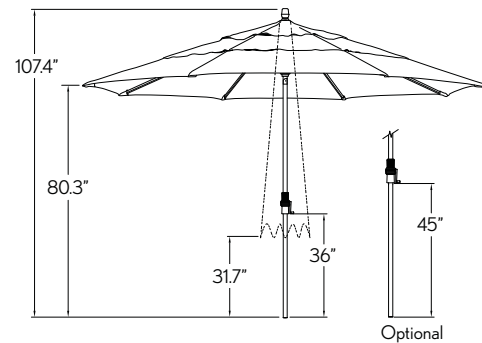

ITEM NO.	Size	Shape	Ribs	Pole Dia.	Bottom Pole	Vents	Lift	Tilt	Weight	Cube	Minimum Base Wt.
<b>UM801</b>	11'	Octagon	8	1.5"	36"	SWV DWV	Crank	Collar	SWV 22 lbs. DWV 23 lbs.	1.74	80 lbs.



**SHOWN:**  
**Item No:** UM8002  
**Fabric:** 6905 Arbor Sky  
**Base:** BA502 (Base sold separately)



MARKET

**FEATURES**

- › Powder coated aluminum
- › Easy to twist collar tilt function
- › Textured two-piece ribbed pole
- › Crank lift system

**GRADE SWV DWV / DC**

A+	<b>\$860</b>	<b>\$895</b>
A	<b>\$675</b>	<b>\$710</b>
C / COM †	<b>\$505</b>	<b>\$535</b>

**NOTE:** Price includes frame and canopy only.  
 †COM - Customer's Own Material. For COM, see page 139.  
 Shipping Information: **Standard Parcel/Courier Services**

**OPTIONS**

› Bottom pole also available in 36" and 45" (page 83)



**UM8000** Bronze  
**UM8002** Anthracite  
**UM8009** Black

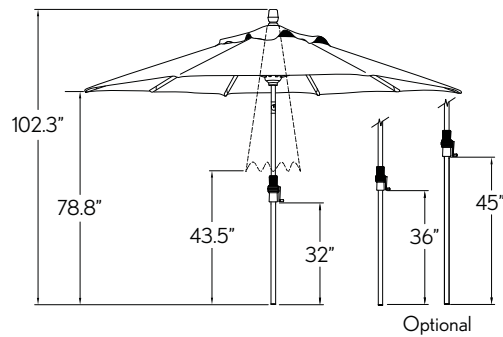

ITEM NO.	Size	Shape	Ribs	Pole Dia.	Bottom Pole	Vents	Lift	Tilt	Weight	Cube	Minimum Base Wt.
<b>UM800</b>	9'	Octagon	8	1.5"	32"	SWV DWV	Crank	Collar	SWV 19 lbs. DWV 20 lbs.	1.74	50 lbs.



**SHOWN:**  
**Item No:** UM8129  
**Fabric:** DC7 Style - 4820 Boulder / 48910 Dakota Stone Stripe  
**Base:** BA509/BW30 (Base/base weight sold separately)



**FEATURES**

- › Powder coated aluminum
- › Automatic crank to tilt canopy
- › 100% Kevlar mesh lift cord for added strength and durability
- › Crank lift system

**GRADE SWV DWV / DC**

A+	<b>\$1,065</b>	<b>\$1,145</b>
A	<b>\$840</b>	<b>\$900</b>
C / COM †	<b>\$670</b>	<b>\$735</b>

**NOTE:** Price includes frame and canopy only.  
 †COM - Customer's Own Material. For COM, see page 139.  
**Shipping Information: Standard Parcel/Courier Services**

**OPTIONS**

- › Bottom pole also available in 45" (page 83)



**UM8120** Bronze    **UM8122** Anthracite    **UM8123** White    **UM8129** Black

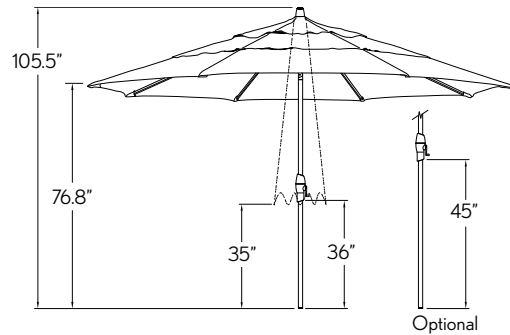

ITEM NO.	Size	Shape	Ribs	Pole Dia.	Bottom Pole	Vents	Lift	Tilt	Weight	Cube	Minimum Base Wt.
<b>UM812</b>	11'	Octagon	8	1.5"	36"	SWV DWV	Crank	Crank	SWV 22 lbs. DWV 23 lbs.	1.74	80 lbs.

MARKET



**SHOWN:**  
**Item No:** UM8102  
**Fabric:** 6904 Moonbean Smoke  
**Base:** BG502 (Base sold separately)



MARKET

**FEATURES**

- › Powder coated aluminum
- › Automatic crank to tilt canopy
- › 100% Kevlar mesh lift cord for added strength and durability
- › Crank lift system

**GRADE SWV DWV / DC**

A+	<b>\$805</b>	<b>\$835</b>
A	<b>\$610</b>	<b>\$640</b>
C / COM †	<b>\$450</b>	<b>\$480</b>

**NOTE:** Price includes frame and canopy only.  
 †COM - Customer's Own Material. For COM, see page 139.  
 Shipping Information: **Standard Parcel/Courier Services**

**OPTIONS**

- › Bottom pole also available in 36" and 45" (page 83)



**UM8100** Bronze    **UM8102** Anthracite    **UM8103** White    **UM8109** Black

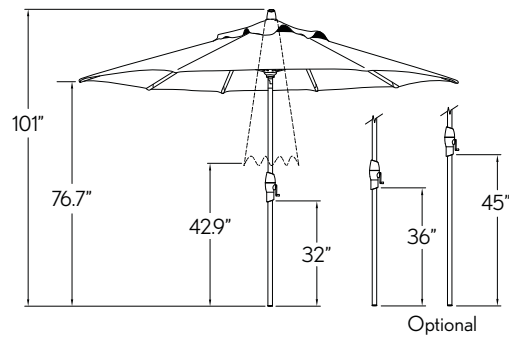

ITEM NO.	Size	Shape	Ribs	Pole Dia.	Bottom Pole	Vents	Lift	Tilt	Weight	Cube	Minimum Base Wt.
<b>UM810</b>	9'	Octagon	8	1.5"	32"	SWV DWV	Crank	Crank	SWV 19 lbs. DWV 20 lbs.	1.74	50 lbs.





**SHOWN:**  
**Item No:** UM8810RT09  
**Fabric:** 14059 Haze  
**Base:** BKMSQ1009 (Base sold separately)



MARKET

**FEATURES**

- › Powder coated aluminum
- › Automatic crank to tilt canopy
- › 100% Kevlar mesh lift cord for added strength and durability
- › Crank lift system

**7823, 7824 AND STRIPED FABRICS NOT AVAILABLE ON THIS STYLE.**

**OPTIONS**

- › Bottom pole also available in 45" (page 83)

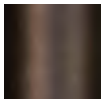

**UM8810RT00**  
Bronze



**UM8810RT02**  
Anthracite



**UM8810RT09**  
Black

**GRADE**

**SWV**

A+	<b>\$1,045</b>
A	<b>\$775</b>
C / COM †	<b>\$635</b>

**NOTE:** Price includes frame and canopy only.  
 †COM - Customer's Own Material. For COM, see page 139.  
 Shipping Information: **Standard Parcel/Courier Services**

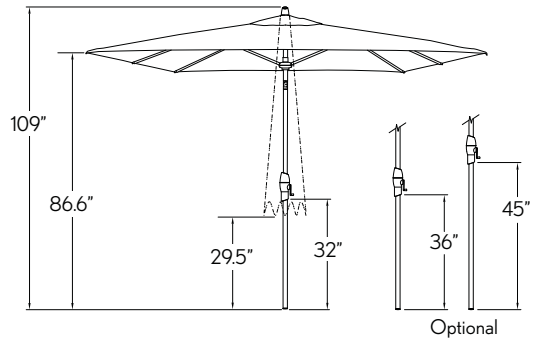

ITEM NO.	Size	Shape	Ribs	Pole Dia.	Bottom Pole	Vent	Lift	Tilt	Weight	Cube	Minimum Base Wt.
<b>UM8810RT0</b>	8'x10'	Rectangle	8	1.5"	36"	SWV	Crank	Crank	22 lbs.	1.9	100 lbs.



**SHOWN:**

**Item No:** UM8811RT03  
**Fabric:** 5439 Navy  
**Base:** BKMSQ1003 (Base sold separately)



MARKET

**FEATURES**

- › Powder coated aluminum
- › 100% Kevlar Mesh Lift Cord for added strength and durability
- › Crank lift system
- › Canopy telescopes upward to close over tabletop

7823, 7824 AND STRIPED FABRICS NOT AVAILABLE ON THIS STYLE.

**OPTIONS**

- › Bottom pole also available in 45" (page 83)

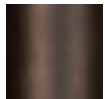

UM8811RT00  
Bronze



UM8811RT03  
White



UM8811RT09  
Black

**GRADE**

**SWV**

A+	<b>\$1,055</b>
A	<b>\$780</b>
C / COM †	<b>\$640</b>

**NOTE:** Price includes frame and canopy only.

†COM - Customer's Own Material. For COM, see page 139.

Shipping Information: **Standard Parcel/Courier Services**

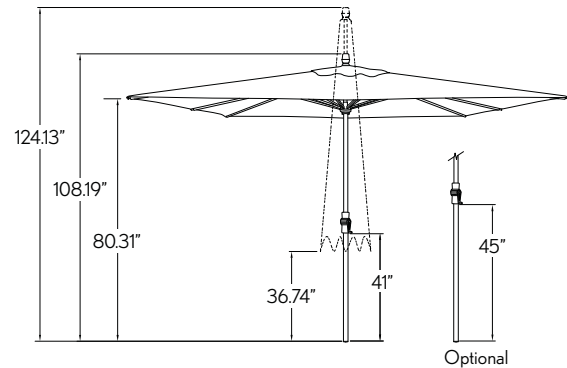

Optional

ITEM NO.	Size	Shape	Ribs	Pole Dia.	Bottom Pole	Vent	Lift	Tilt	Weight	Cube	Minimum Base Wt.
<b>UM8811RT0</b>	8'x11'	Rectangle	8	1.5"	41"	SWV	Crank	n/a	23 lbs.	2.1	100 lbs.



**SHOWN:**  
**Item No:** UM9709  
**Fabric:** 48911 Providence Navy Stripe  
**Base:** BW509 (Base sold separately)



**FEATURES**

- › Powder coated aluminum
- › Revolutionary slide to tilt canopy function
- › Crank lift system

**OPTIONS**

- › Bottom pole also available in 36" and 45" (page 83)

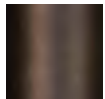

**UM9700**  
Bronze



**UM9709**  
Black

GRADE	SWV	DWV / DC
A+	<b>\$620</b>	<b>\$660</b>
A	<b>\$520</b>	<b>\$565</b>
C / COM †	<b>\$370</b>	<b>\$405</b>

**NOTE:** Price includes frame and canopy only.  
 †COM - Customer's Own Material. For COM, see page 139.  
 Shipping Information: **Standard Parcel/Courier Services**

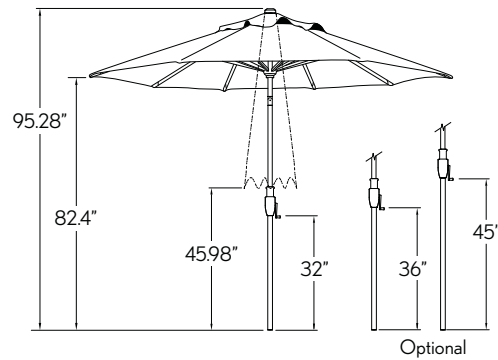

ITEM NO.	Size	Shape	Ribs	Pole Dia.	Bottom Pole	Vents	Lift	Tilt	Weight	Cube	Minimum Base Wt.
<b>UM970</b>	9'	Octagon	8	1.5"	32"	SWV DWV	Crank	Glide	SWV 18 lbs. DWV 19 lbs.	1.53	50 lbs.

MARKET



**SHOWN:**  
**Item No:** UM9770  
**Fabric:** 48135-02 Bliss Sand  
**Base:** BW500 (Base sold separately)



**FEATURES**

- › Powder coated aluminum
- › Revolutionary slide to tilt canopy function
- › Crank lift system
- › Great for small areas

**GRADE**

**SWV**

A+	<b>\$535</b>
A	<b>\$440</b>
C / COM †	<b>\$335</b>

**NOTE:** Price includes frame and canopy only.  
 †COM - Customer's Own Material. For COM, see page 139.  
 Shipping Information: **Standard Parcel/Courier Services**

**OPTIONS**

- › Bottom pole also available in 36" and 45" (page 83)

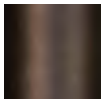

**UM9770**  
Bronze



**UM9779**  
Black

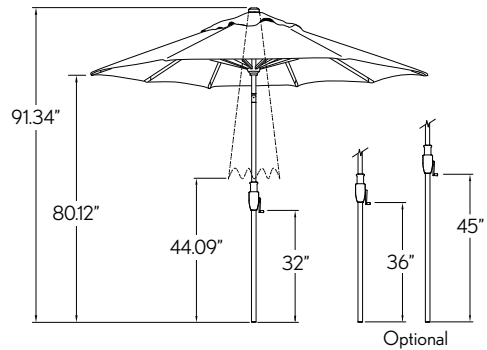

ITEM NO.	Size	Shape	Ribs	Pole Dia.	Bottom Pole	Vent	Lift	Tilt	Weight	Cube	Minimum Base Wt.
<b>UM977</b>	7.5'	Octagon	8	1.5"	32"	SWV	Crank	Glide	15 lbs.	1.4	50 lbs.



**SHOWN:**  
**Item No:** UM9200  
**Fabric:** DC4 Style - 4807 Auburn / 48907 Tuscan Redwood Stripe  
**Base:** BW500 (Base sold separately)



MARKET

**FEATURES**

- › Powder coated aluminum
- › Manual push button, two-way tilt canopy
- › Crank lift system

GRADE	SWV	DWV / DC
A+	<b>\$615</b>	<b>\$655</b>
A	<b>\$450</b>	<b>\$500</b>
C / COM †	<b>\$350</b>	<b>\$370</b>

**NOTE:** Price includes frame and canopy only.  
 †COM - Customer's Own Material. For COM, see page 139.  
 Shipping Information: **Standard Parcel/Courier Services**

**OPTIONS**

› Bottom pole also available in 36" and 45" (page 83)

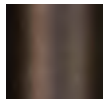

**UM9200**  
Bronze



**UM9202**  
Anthracite



**UM9203**  
White



**UM9209**  
Black

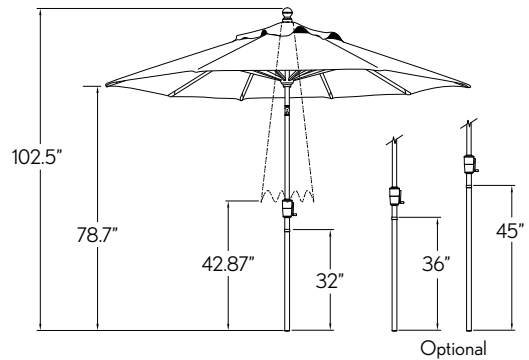

ITEM NO.	Size	Shape	Ribs	Pole Dia.	Bottom Pole	Vents	Lift	Tilt	Weight	Cube	Minimum Base Wt.
<b>UM920</b>	9'	Octagon	8	1.38" Top Pole 1.5" Bottom Pole	32"	SWV DWV	Crank	Push Button	SWV 17 lbs. DWV 18 lbs.	1.74	50 lbs.



**SHOWN:**  
**Item No:** UM9073  
**Fabric:** 4838 Lemon  
**Base:** BW503 (Base sold separately)



MARKET

**FEATURES**

- › Powder coated aluminum
- › Manual push button, two-way tilt canopy
- › Crank lift system
- › Great for small areas

**GRADE**

**SWV**

A+	<b>\$490</b>
A	<b>\$380</b>
C / COM †	<b>\$300</b>

**NOTE:** Price includes frame and canopy only.  
 †COM - Customer's Own Material. For COM, see page 139.  
 Shipping Information: **Standard Parcel/Courier Services**

**OPTIONS**

- › Bottom pole also available in 45" (page 83)

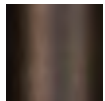

**UM9070**  
Bronze



**UM9073**  
White



**UM9079**  
Black

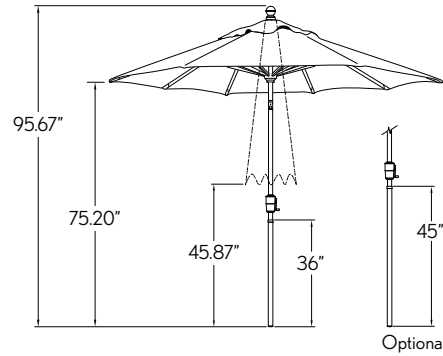

ITEM NO.	Size	Shape	Ribs	Pole Dia.	Bottom Pole	Vent	Lift	Tilt	Weight	Cube	Minimum Base Wt.
<b>UM907</b>	7.5'	Octagon	8	1.38" Top Pole 1.5" Bottom Pole	36"	SWV	Crank	Push Button	14 lbs.	1.45	50 lbs.



**SHOWN:**

**Item No:** UM8091  
**Fabric:** DC7 Style - 5446 Forest Green / 5404 Natural  
**Base:** BW500 (Base sold separately)



MARKET

**FEATURES**

- › Quad pulley lift system
- › Aluminum alloy locking pin
- › FSC hardwood



Our Hardwood umbrella is crafted of FSC - certified from well-managed forests.  
 Our wood products are distinguished by any of the following characteristics: Organic, Recycled, Reclaimed or Sustainable.



**UM8091**  
Hardwood

GRADE	SWV	DWV / DC
A+	<b>\$615</b>	<b>\$665</b>
A	<b>\$460</b>	<b>\$510</b>
C / COM †	<b>\$360</b>	<b>\$385</b>

**NOTE:** Price includes frame and canopy only.  
 †COM - Customer's Own Material. For COM, see page 139.  
 Shipping Information: **Standard Parcel/Courier Services**

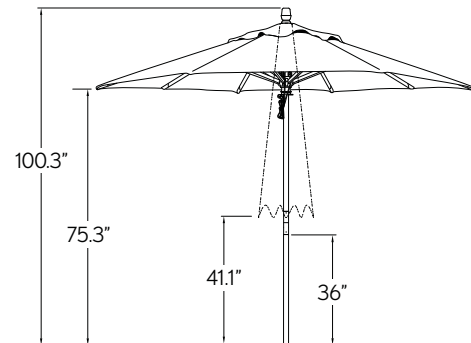

ITEM NO.	Size	Shape	Ribs	Pole Dia.	Bottom Pole	Vents	Lift	Tilt	Weight	Cube	Minimum Base Wt.
<b>UM8091</b>	9'	Octagon	8	1.5"	36"	SWV DWV	Quad Pulley	n/a	SWV 23 lbs. DWV 24 lbs.	1.72	50 lbs.

## Commercial Collection

---

9' Commercial  
Octagon Series

7' Commercial  
Square Series

**Shown:**

**Umbrella:**

UCP409-09D

5403 Jockey Red

**Base Option:**

BSK1209









**SHOWN:**  
**Item No:** UCP409-09  
**Fabric:** 6669 Horizon Night Stripe  
**Base:** BKM1009 (Base sold separately)



COMMERCIAL

**FEATURES**

- › Aluminum center pole and ribs
- › Easy push-up umbrella and pops into place
- › Stainless steel locking pin
- › 16 gauge center pole (approx. 1/16 inch)

**OPTIONS**

› Valance (Add "V" to item no.) - Example: **UCP409-SSV**



**UCP409-SS**  
Silver Shadow  
Anodized



**UCP409-00**  
Bronze



**UCP409-09**  
Black

GRADE	SWV	SWV w/ V	DWV   DC	DWV w/ V
A+ *	\$800	\$950	\$845	\$1,000
A/  <i>Opavria</i> Awning Grade	\$655	\$780	\$695	\$825
C / COM †	\$510	\$590	\$555	\$640

**NOTE:** Price includes frame and canopy only. \**sunbrella* Awning Grade available at a 20% upcharge.

†COM - Customer's Own Material. For COM, see page 139.

Shipping Information: **Standard Parcel/Courier Services. Oversized - Additional shipping costs for this style.**

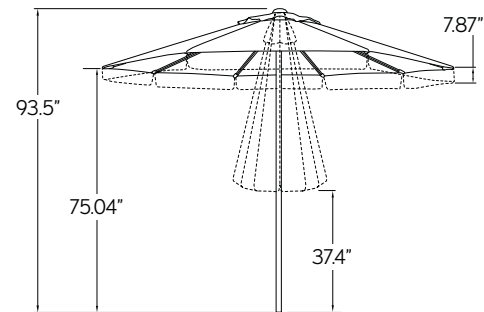

ITEM NO.	Size	Shape	Ribs	Pole Dia.	Pole Wall	Vents	Lift	Tilt	Weight	Cube	Minimum Base Wt.
<b>UCP409</b>	9'	Octagon	8	1.53"	1/16"	SWV DWV	Pop-up	n/a	SWV (-V) 22 lbs. (23 lbs.) DWV (-V) 24 lbs. (25 lbs.)	2.62	70 lbs.



**SHOWN:**  
**Item No:** UCP407SQ-SS  
**Fabric:** 6733 Kinzie Royal Stripe  
**Base:** BKMSQ1009 (Base sold separately)



**FEATURES**

- › Aluminum center pole and ribs
- › Easy push-up umbrella and pops into place
- › Stainless steel locking pin
- › 16 gauge center pole (approx. 1/16 inch)

7823 & 7824 FABRICS NOT AVAILABLE ON THIS STYLE.

**OPTIONS**

- › Valance (Add "V" to item no.) - Example: UCP407SQ-SSV



UCP407SQ-SS  
Silver Shadow  
Anodized



UCP407SQ-09  
Black

GRADE	SWV	SWV w/ Valance
A+ *	\$775	\$920
A/  Awning Grade	\$635	\$770
C / COM †	\$475	\$560

**NOTE:** Price includes frame and canopy only. \* Awning Grade available at a 20% upcharge.

†COM - Customer's Own Material. For COM, see page 139.

Shipping Information: **Standard Parcel/Courier Services. Oversized - Additional shipping costs for this style.**

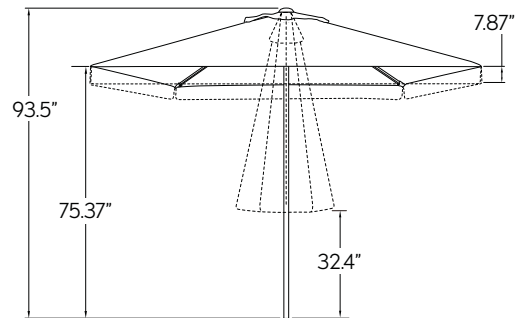

ITEM NO.	Size	Shape	Shade Coverage	Ribs	Pole Dia.	Pole Wall	Vent	Lift	Tilt	Weight	Cube	Minimum Base Wt.
<b>UCP407SQ</b>	7'	Square	49 sq. ft.	4	1.53"	1/16"	SWV	Pop-up	n/a	SWV 18 lbs. SWV-V 19 lbs.	2.62	70 lbs.

## Fabric Collection

---

100% Solution-Dyed Acrylic  
Grade A+

100% Solution-Dyed Acrylic  
Grade A

100% Solution-Dyed Polyester  
Grade C





# FABRIC | Collection

Treasure Garden offers a wide selection of fabrics from acrylic, to our exclusive high performance, environmentally friendly fabric - O'bravia®. These fabrics will allow your customers to find the perfect selections to complement their outdoor environment.

TGEx "Quick-Ship" program is available in select fabrics in our 7.5' and 9' Single Wind Vent (SWV) & 11' Double Wind Vent (DWV).  
 CQS "Quick-Ship" program is available in select fabrics and cantilever styles.

For ordering information on our programs - see pages 94-95



## GRADE A+ - 100% Solution-Dyed Acrylic



**6901** A+  
Bedrock Sky



**6902** A+  
Bedrock Smoke



**6903** A+  
Moonbeam Cobalt

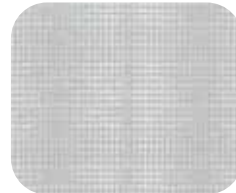

**6904** A+  
Moonbeam Smoke



**6905** A+  
Arbor Sky

## GRADE A - 100% Solution-Dyed Acrylic

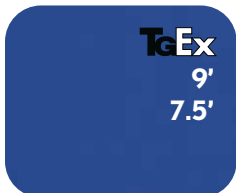

**5401** A  
Pacific Blue

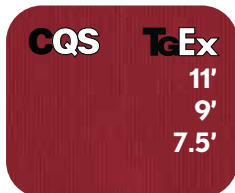

**5403** A  
Jockey Red

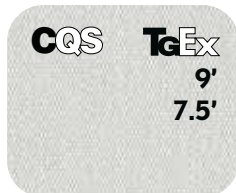

**5404** A  
Natural

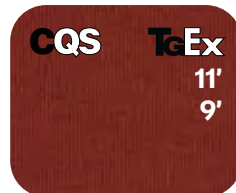

**5407** A  
Henna



**5408** A  
Black

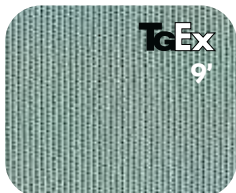

**5413** A  
Spa



**5416** A  
Aruba



**5417** A  
Tuscan

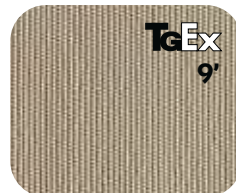

**5422** A  
Antique Beige



**5425** A  
Cocoa



**5438** A  
Buttercup



**5439** A  
Navy

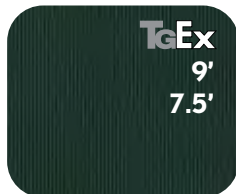

**5446** A  
Forest Green



**5453** A  
Canvas

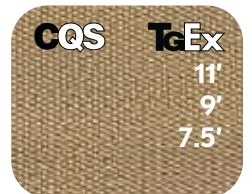

**5476** A  
Heather Beige

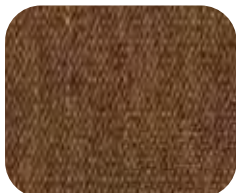

**5488** A  
Teak



**6407** A  
Aquatic



**6433** A  
Neptune



**6439** A  
Ink



**6447** A  
Surf

**GRADE A - 100% Solution-Dyed Acrylic** (continued)



**6457** A  
Beacon Ash



**6461** A  
Taupe



**6463** A  
Reseda



**6660** A  
Harper Ink Stripe

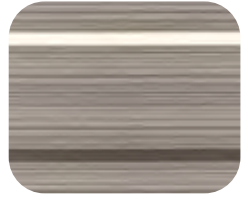

**6661** A  
Harper Putty Stripe



**6662** A  
Harper Steel Stripe



**6663** A  
Harper Crimson Stripe



**6664** A  
Churchill Beach Stripe

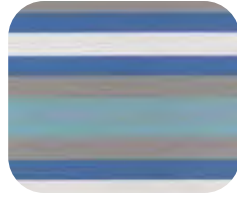

**6666** A  
Paddock Aqua Stripe



**6667** A  
Kinzie Smoke Stripe



**6668** A  
Kinzie Coal Stripe



**6669** A  
Horizon Night Stripe



**6670** A  
Reliant Coast Stripe



**6703** A  
Kinzie Rose Stripe



**6711** A  
Kinzie Grass Stripe



**6733** A  
Kinzie Royal Stripe



**7816** A  
Tango Glacier



**7822** A  
Mosaic Tile



**7823** A  
Atlantic Beechwood

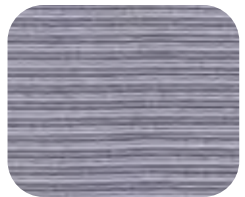

**7824** A  
Atlantic Coast



**7825** A  
Tango Truffle



**7853** A  
Tango Pearl



**8318** A  
Sesame Linen



**14059** A  
Haze



**14067** A  
Mushroom



**40428** A  
Cast Ash

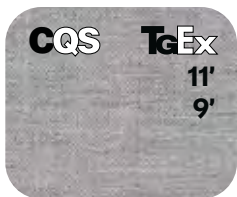

**40433** A  
Cast Silver



**40434** A  
Cast Slate



**40456** A  
Cast Lagoon



**40524-01** A  
Trusted Fog Stripe

# FABRIC | Collection

## GRADE A - 100% Solution-Dyed Acrylic (continued)

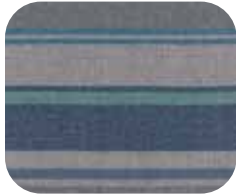

**40524-02** A  
Trusted Coast Stripe



**40584-01** A  
Surround Dusk Stripe



**48080** A  
Spectrum Indigo



**48103S** A  
Cast Ocean



**48135-02** A  
Bliss Sand



**48135-04** A  
Bliss Onyx



**48135-10** A  
Bliss Pebble

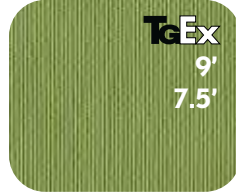

**54011** A  
Ginkgo



**54048** A  
Charcoal



**56079** A  
Milano Char Stripe



**56080** A  
Milano Cobalt Stripe



**56095** A  
Astoria Sunset Stripe



**56096** A  
Astoria Lagoon Stripe



**58039** A  
Gateway Mist Stripe

**NOTE:** Fabric swatches shown are not to scale. Colors may vary slightly from the actual fabric; please refer to the TG Fabric Swatch Book to view true color and detail.

## GRADE C - 100% Solution-Dyed Polyester

EXCLUSIVE



**4800** C  
Champagne



**4801** C  
Cobalt

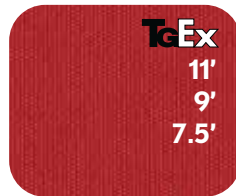

**4803** C  
Red



**4804** C  
Eggshell



**4807** C  
Auburn



**4808** C  
Black



**4809** C  
Burnt Orange

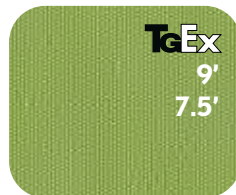

**4811** C  
Kiwi



**4812** C  
Silver Linen



**4813** C  
Spa



**GRADE C - 100% Solution-Dyed Polyester** (continued)

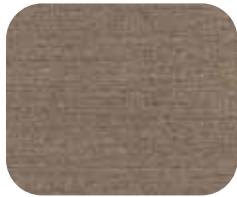

**4814** C  
Straw

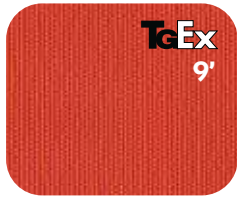

**4815** C  
Sunset

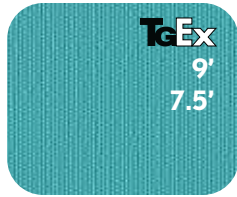

**4816** C  
Aqua

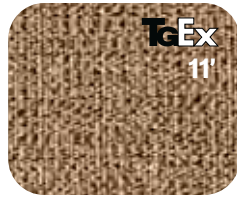

**4818** C  
Sesame

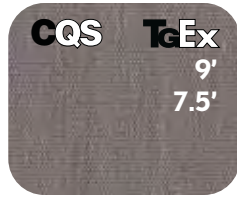

**4820** C  
Boulder



**4822** C  
Khaki



**4825** C  
Mocha

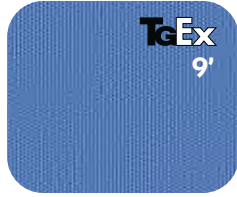

**4826** C  
Sky



**4827** C  
Chocolate



**4834** C  
Carbon



**4838** C  
Lemon

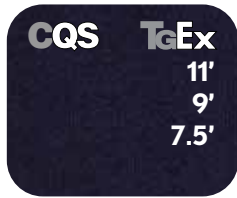

**4839** C  
Navy

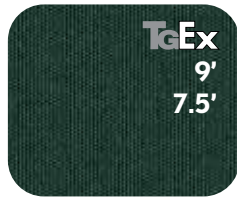

**4846** C  
Forest Green



**4850** C  
Latitude Gray



**4851** C  
Latitude Navy



**4853** C  
Vanilla



**4861** C  
Taupe

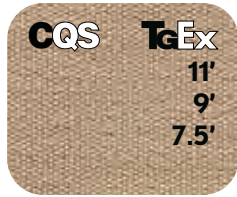

**4876** C  
Sand



**4881** C  
Blue Jay



**4886** C  
Sahara Stripe



**4891** C  
Black Latte Stripe



**4899** C  
Hampton Stripe



**48011** C  
Ridge Beach



**48066** C  
Ridge Canyon



**48907** C  
Tuscan Redwood Stripe



**48910** C  
Dakota Stone Stripe



**48911** C  
Providence Navy Stripe



**48913** C  
Vancouver Coast Stripe









**48919** C  
Richmond Stone Stripe

# FABRIC INDEX | Collection

FABRIC

Fabric Item No.	Fabric Name	Swatch Book Page No.	Fabric Grade	Quick-Ship				Fabric Item No.	Fabric Name	Swatch Book Page No.	Fabric Grade	Quick-Ship			
				7.5' (SWV)	9' (SWV)	11' (DWV)	Cantilever					7.5' (SWV)	9' (SWV)	11' (DWV)	Cantilever
2402	Banana	98L	D*					4820	Boulder	73	C	✓	✓		✓
2406	Blue Sky	95L	D*					4822	Khaki	94C	C	✓	✓	✓	
2407	Henna	97R	D*					4825	Mocha	92C	C				
2408	Black	100R	D*					4826	Sky	90L	C		✓		
2410	Pottery	95R	D*					4827	Chocolate	75	C				
2412	Really Red	96R	D*					4834	Carbon	94L	C				
2429	Macaw	99L	D*					4838	Lemon	87R	C	✓	✓		
2439	Navy	97L	D*					4839	Navy	69	C	✓	✓	✓	✓
2446	Forest Green	100L	D*					4846	Forest Green	92R	C	✓	✓		
2470	Walnut	100C	D*					4850	Latitude Gray	80	C				
3400	Champagne	97C	D*					4851	Latitude Navy	79	C				
3409	Terra Cotta	98R	D*					4853	Vanilla	89C	C				
3450	Charcoal	99R	D*					4861	Taupe	91C	C				
3454	Toffee	98C	D*					4876	Sand	93C	C	✓	✓	✓	✓
3500	Champagne Linen	95C	D*					4881	Blue Jay	67	C				
3504	Cream	96C	D*					4886	Sahara Stripe	76	C				
3518	Sesame Linen	99C	D*					4891	Black Latte Stripe	78	C				
3539	Indigo	96L	D*					4899	Hampton Stripe	70	C				
4800	Champagne	82	C					48011	Ridge Beach	85	C				
4801	Cobalt	91L	C	✓	✓			48066	Ridge Canyon	86	C				
4803	Red	90R	C	✓	✓	✓		48907	Tuscan Redwood Stripe	64	C				
4804	Eggshell	71	C					48910	Dakota Stone Stripe	74	C				
4807	Auburn	63	C		✓			48911	Providence Navy Stripe	68	C				
4808	Black	77	C		✓		✓	48913	Vancouver Coast Stripe	66	C				
4809	Burnt Orange	89R	C					48919	Richmond Stone Stripe	72	C				
4811	Kiwi	93R	C	✓	✓			5401	Pacific Blue	54R	A	✓	✓		
4812	Silver Linen	81	C					5403	Jockey Red	51L	A	✓	✓	✓	✓
4813	Spa	65	C		✓			5404	Natural	10	A	✓	✓		✓
4814	Straw	84	C					5407	Henna	52L	A		✓	✓	✓
4815	Sunset	88R	C		✓			5408	Black	7	A	✓	✓	✓	
4816	Aqua	87L	C	✓	✓			5413	Spa	60R	A		✓		
4818	Sesame	83	C			✓		5416	Aruba	52R	A				

\*Grade D - AVAILABLE ON ONLY.

Fabric Item No.	Fabric Name	Swatch Book Page No.	Fabric Grade	Quick-Ship				Fabric Item No.	Fabric Name	Swatch Book Page No.	Fabric Grade	Quick-Ship			
				7.5' (SWV)	9' (SWV)	11' (DWW)	Cantilever					7.5' (SWV)	9' (SWV)	11' (DWW)	Cantilever
															
5417	Tuscan	53L	A					6904	Moonbeam Smoke	3	A+				
5422	Antique Beige	52C	A		✓			6905	Arbor Sky	1	A+				
5425	Cocoa	59C	A					7816	Tango Glacier	48	A				
5438	Buttercup	54L	A					7822	Mosaic Tile	36	A				
5439	Navy	58R	A	✓	✓		✓	7823	Atlantic Beechwood	37	A				
5446	Forest Green	60C	A	✓	✓			7824	Atlantic Coast	15	A				
5453	Canvas	51C	A			✓		7825	Tango Truffle	50	A				
5476	Heather Beige	54C	A	✓	✓	✓	✓	7853	Tango Pearl	49	A				
5488	Teak	25	A					8318	Sesame Linen	56C	A				
6407	Aquatic	51R	A					14059	Haze	46	A				
6433	Neptune	57R	A					14067	Mushroom	45	A				
6439	Ink	20	A					40428	Cast Ash	55C	A				
6447	Surf	8	A					40433	Cast Silver	55L	A		✓	✓	✓
6457	Beacon Ash	11	A					40434	Cast Slate	58L	A				
6461	Taupe	58C	A					40456	Cast Lagoon	61R	A				
6463	Reseda	28	A					40524-01	Trusted Fog Stripe	40	A				
6660	Harper Ink Stripe	19	A					40524-02	Trusted Coast Stripe	21	A				
6661	Harper Putty Stripe	38	A					40584-01	Surround Dusk Stripe	39	A				
6662	Harper Steel Stripe	33	A					48080	Spectrum Indigo	47	A				
6663	Harper Crimson Stripe	31	A					48103S	Cast Ocean	53R	A				
6664	Churchill Beach Stripe	23	A					48135-02	Bliss Sand	44	A				
6666	Paddock Aqua Stripe	18	A					48135-04	Bliss Onyx	42	A				
6667	Kinzie Smoke Stripe	14	A					48135-10	Bliss Pebble	43	A				
6668	Kinzie Coal Stripe	13	A					54011	Ginkgo	26	A	✓	✓		
6669	Horizon Night Stripe	6	A					54048	Charcoal	59L	A				
6670	Reliant Coast Stripe	9	A					56079	Milano Char Stripe	41	A				
6703	Kinzie Rose Stripe	32	A					56080	Milano Cobalt Stripe	12	A				
6711	Kinzie Grass Stripe	27	A					56095	Astoria Sunset Stripe	30	A				
6733	Kinzie Royal Stripe	16	A					56096	Astoria Lagoon Stripe	24	A				
6901	Bedrock Sky	5	A+					58039	Gateway Mist Stripe	22	A				
6902	Bedrock Smoke	4	A+												
6903	Moonbeam Cobalt	2	A+												

Note: **Tex** is available in select fabrics in our 7.5' and 9' Single Wind Vent (SWV) & 11' Double Wind Vent (DWW).

**CQS** is available in select fabrics and cantilever styles.

## General Information

### 100% Solution-Dyed Acrylic Fabrics:

Grade A+/A

Limited warranty: 5 years against fading



For the complete line of our  
Care & Maintenance products  
See pages 80-81

### 100% Solution-Dyed Polyester Fabrics:

Grade C (Our exclusive 4800 series) 

Limited warranty: 4 years against fading

**MOST STAINS ON SOLUTION-DYED FABRICS CAN BE CLEANED UP WITH TREASURE GARDEN'S UPHOLSTERY & FABRIC CLEANER (TGC-UFC-32) OR A NATURAL MILD SOAP AND WATER SOLUTION.** Solution-Dyed fabrics should be cleaned regularly before substances such as dirt, etc., are allowed to accumulate on and become embedded in the fabric. The fabric can be cleaned without being removed from the umbrella. Simply brush off any loose dirt, etc., clean with warm water (no more than 100° F) and a cleaner such as our **Upholstery & Fabric Cleaner (TGC-UFC-32)** or a mild natural soap. Rinse thoroughly to remove cleaner. It may be necessary to re-apply a water repellent treatment, such as our **Upholstery & Fabric Protector (TGC-UFP-32)**. When washing or cleaning, **DO NOT SUBJECT TO EXCESSIVE HEAT** as the fabric will shrink. **DO NOT STEAM PRESS OR DRY IN ELECTRIC OR GAS DRYERS.** Allow fabric to air dry. In case Solution-Dyed fabrics are stored during the winter season, it should be cleaned, allowed to air dry and stored in a dry, well ventilated area. For stubborn stains, please see the stain cleaning chart below for more specific cleaning instructions.

### STAIN CLEANING CHART

STAINS	Recommended Cleaning Solutions	STAINS	Recommended Cleaning Solutions
BEER	• liquid detergent, white vinegar	MILDEW	• 1/2 cup of bleach and 1/4 cup natural soap per gallon of water
BERRY	• liquid detergent/ammonia (3-6% water)	MILK	• liquid detergent
BLOOD (dried)	• detergent/ammonia (3-6% water)	NAIL POLISH	• volatile solvent (acetone)
BUTTER	• volatile solvent (acetone)	OIL	• volatile solvent (acetone)
CHARCOAL, PENCIL MARKS	• vacuum, then liquid detergent	ORANGE DRINK	• liquid detergent, water
CATSUP OR MUSTARD	• liquid detergent	PAINT (latex) WET	• liquid detergent, water
CHEWING GUM	• volatile solvent (acetone)	PAINT (latex) DRIED	• paint, oil or grease remover
CHOCOLATE	• liquid detergent, ammonia water	PAINT (oil or lacquer)	• paint, oil or grease remover
COFFEE	• detergent, white vinegar volatile solvent (acetone)	SHOE POLISH (liquid)	• volatile solvent (acetone)
COLA	• liquid detergent	SHOE POLISH (wax)	• apply heated iron over towel, volatile solvent (acetone)
CRAYON	• paint, oil or grease remover	SUNTAN LOTION	• Pine Power or pine oil detergent
EGG (raw)	• liquid detergent	TEA	• liquid detergent
GRAPE JUICE	• liquid detergent (water)	TOMATO JUICE	• liquid detergent
GRAVY	• liquid detergent	TREE SAP	• turpentine, liquid detergent
GREASE	• volatile solvent (acetone)	URINE	• liquid detergent, white vinegar
INK	• paint remover, volatile solvent (acetone), detergent	VOMIT	• detergent, water, white vinegar
IRON RUST	• oxalic or citrus acids, water	WATER COLOR	• liquid detergent, water, white vinegar
LIPSTICK	• paint, oil or grease remover	WAX (candle)	• apply heated iron over towel, volatile solvent (acetone)
MASCARA	• paint remover, volatile solvent (acetone), detergent	WINE	• liquid detergent/ammonia (3-6% water), white vinegar

### Protective Furniture Covers - RhinoWeave®

Limited warranty: 1 year against fading and free of manufacturer's defects (stitching, elastics, velcro)

RhinoWeave fabric should be cleaned periodically with mild soap and water & scrub with soft brush. After cleaning, always rinse thoroughly with clean water and allow to air dry. **DO NOT USE BLEACH.**



**Shown:**

Umbrella:  
UM8002  
6439 Ink

Base:  
BA502

Rug:  
RG-334-369-35 (5'3" x 7'4")  
Reflections - Ocean Blue

## Base Collection

---

### Commercial

BA150 Series

### Steel Base w/casters

BSK120 Series

### Monaco w/wheels & handle

BKM100 Series

BKMSQ100 Series

### Art Deco

BA50 Series

### Garden

BG50 Series

### Classic

BW50 Series

### Steel Bases

BS359 Series

BS70\_-2.0 Series

### Base Options



# UMBRELLA | Base Collection

## Commercial BA150 Series

- RESIDENTIAL
- COMMERCIAL

**Features:**

- > Cast Aluminum Shell w/ Cast Iron Core
- > Dual-Purpose Stem

**Options:**

- > Aluminum Stem for 2" poles

BT2-0\_

## Cast Aluminum 150 lbs.

**Item No.:**

BA1500      Bronze



BA1509      Black



Compatible with Shademaker Libra styles, see page 99.

Diameter	Weight	Cube	Pallet	MSRP
22"	150 lbs.	2.8	12	<b>\$710</b>

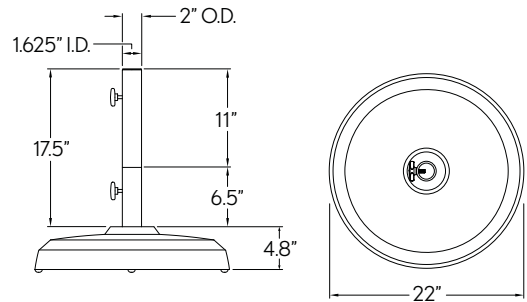

Shipping Information: Truck only

## Steel Base w/ casters BSK120 Series

- RESIDENTIAL
- COMMERCIAL

**Features:**

- > Accomodates 2" pole diameter
- > Dual-Purpose Stem
- > Includes Reducer to accomodate 1.5" pole diameter
- > (2) Nylon Locking Casters
- > (2) Nylon Standard Casters

## Steel 120 lbs.

**Item No.:**

BSK1200      Bronze



BSK1209      Black



Compatible with Shademaker Libra styles, see page 99.

Diameter	Weight	Cube	Pallet	MSRP
20.28"	120 lbs.	1.4	16	<b>\$625</b>



**Locking Casters**

Easy to roll and lock your shade where needed.

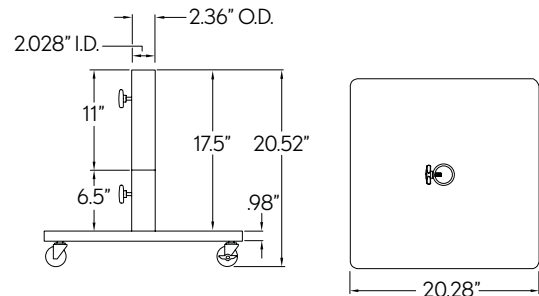

Shipping Information: Truck only



**Monaco w/ wheels & handle  
BKM100 Round Series**

RESIDENTIAL  
COMMERCIAL

**Features:**

- › Cast Aluminum Shell w/ Cast Iron Core
- › Dual-Purpose Stem

**Options:**

- › Add-on Weight (30 lbs.)
- › Aluminum Stem for 2" poles

BW30  
BT2-0\_





Diameter	Weight	Cube	Pallet	MSRP
22"	100 lbs.	2.3	24	<b>\$590</b>



Shipping Information: Truck only

**Cast Aluminum 100 lbs.**

**Item No.:**

BKM1000	Bronze	
BKM1003	White	
BKM1005T	Platinum	
BKM1009	Black	

Compatible with Shademaker Libra styles, see page 99.



**Easy to move your shade -**  
Base rolls easily on 2 wheels.

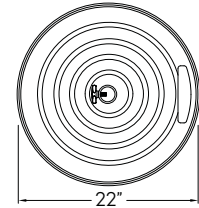
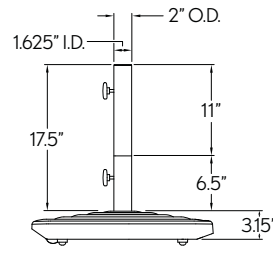

**Monaco w/ wheels & handle  
BKMSQ100 Square Series**

RESIDENTIAL  
COMMERCIAL

**Features:**

- › Cast Aluminum Shell w/ Cast Iron Core
- › Dual-Purpose Stem

**Options:**

- › Add-on Weight (30 lbs.)
- › Aluminum Stem for 2" poles

BW30  
BT2-0\_





Diameter	Weight	Cube	Pallet	MSRP
19.68"	100 lbs.	1.8	24	<b>\$590</b>



Shipping Information: Truck only

**Cast Aluminum 100 lbs.**

**Item No.:**

BKMSQ1000	Bronze	
BKMSQ1003	White	
BKMSQ1005T	Platinum	
BKMSQ1009	Black	

Compatible with Shademaker Libra styles, see page 99.



**Easy to move your shade -**  
Base rolls easily on 2 wheels.

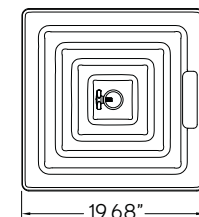
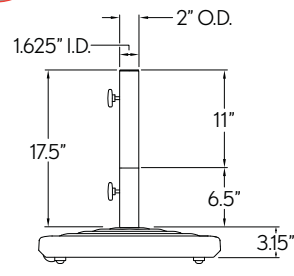

UMBRELLA BASES

# UMBRELLA | Base Collection

UMBRELLA BASES

## Art Deco BA50 Series

RESIDENTIAL

### Features:

- › Cast Aluminum Shell w/ Cast Iron Core
- › Dual-Purpose Stem

### Options:





- › Add-on Weight (30 lbs.)
- › Aluminum Stem for 2" poles

BW30  
BT2-O\_

Diameter	Weight	Cube	Pallet	MSRP
20.9"	50 lbs.	1.5	40	<b>\$275</b>

## Cast Aluminum 50 lbs.

### Item No.:

BA500	Bronze	
BA502	Anthracite	
BA503	White	
BA509	Black	

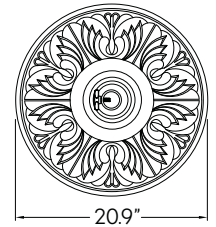
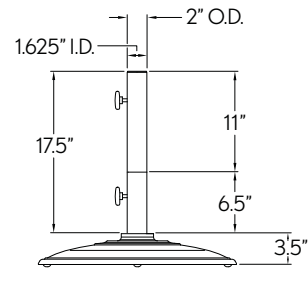

Shipping Information: Standard Parcel/Courier Services

## Garden BG50 Series

RESIDENTIAL

### Features:

- › Cast Aluminum Shell w/ Cast Iron Core
- › Dual-Purpose Stem

### Options:



- › Add-on Weight (30 lbs.)
- › Aluminum Stem for 2" poles

BW30  
BT2-O\_

Diameter	Weight	Cube	Pallet	MSRP
19.5"	50 lbs.	1.4	40	<b>\$280</b>

## Cast Aluminum 50 lbs.

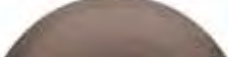
### Item No.:

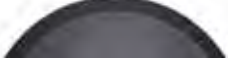
BG500	Bronze	
BG502	Anthracite	
BG503	White	
BG509	Black	

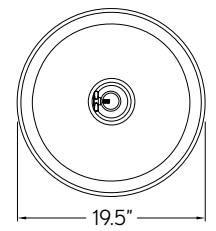
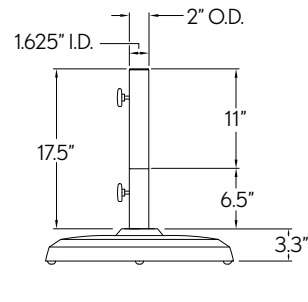

Shipping Information: Standard Parcel/Courier Services

**Classic  
BW50 Series**

**RESIDENTIAL**

**Features:**

- › Cast Iron
- › Dual-Purpose Stem

**Options:**





- › Add-on Weight (30 lbs.)
- › Aluminum Stem for 2" poles

**BW30  
BT218\_**

Diameter	Weight	Cube	Pallet	MSRP
19.3"	50 lbs.	1.4	40	<b>\$175</b>

**Cast Iron 50 lbs.**

**Item No.:**

BW500	Bronze	
BW502	Anthracite	
BW503	White	
BW509	Black	

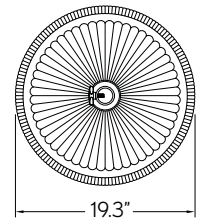
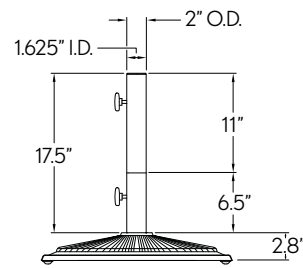

Shipping Information: Standard Parcel/Courier Services

**Base Options**

**Add-On Weight**

The patented BW30 is an optional cast iron 30 lb. weight that can be added onto our 50 lb. or 100 lb. bases.

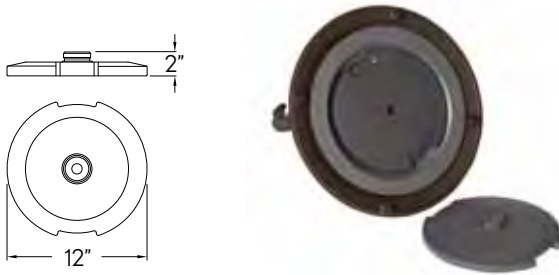

**Cast Iron 30 lbs.**

**Item No.:**

BW30	30 lbs. Add-On Weight
------	-----------------------

**Specifications:**

Diameter	12"
Weight	30 lbs.
Cube	0.52
Pallet	99

**Note:**

Recommended for use with free-standing umbrella applications.

**MSRP: \$100**



**Aluminum Stem for 2" Poles**

The optional Aluminum Stem accommodates larger pole diameter market umbrellas. *Not designed for steel bases.*

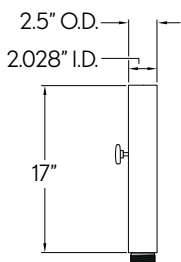

**Specifications:**

Height	17"
Weight	3 lbs.
Cube	0.2

**MSRP: \$70**



**Aluminum Stem**

For Cast Aluminum bases.

**Item No.:**

<b>BT2-00</b>	Bronze
<b>BT2-02</b>	Anthracite
<b>BT2-03</b>	White
<b>BT2-5T</b>	Platinum
<b>BT2-09</b>	Black

**Aluminum Stem**

For BW50 series only.

**Item No.:**

<b>BT2180</b>	Bronze
<b>BT2182</b>	Anthracite
<b>BT2183</b>	White
<b>BT2189</b>	Black

**UMBRELLA BASES**

# UMBRELLA | Base Collection

UMBRELLA BASES

## Steel BS359 Base

RESIDENTIAL

Steel 35 lbs.

**Features:**

- > Dual-Purpose Stem

Item No.:

<b>BS359</b>	<b>Black</b>	
--------------	--------------	---

Shipping Information: Standard Parcel/Courier Services

Size	Weight	Cube	Pallet	MSRP
18"	35 lbs.	1	60	<b>\$150</b>

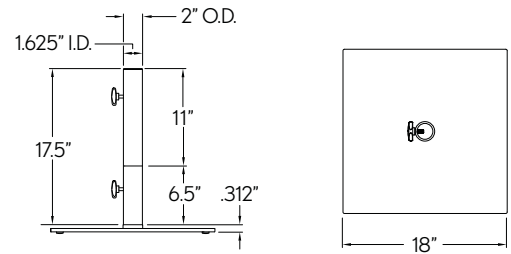

**Note:** NOT recommended for free-standing umbrella applications.

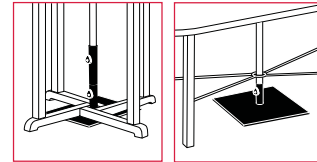

Under-the-table applications



## Steel BS70\_-2.0 Base

RESIDENTIAL

COMMERCIAL

Steel 70 lbs.

**Features:**

- > Accommodates 2" pole diameter
- > Dual-Purpose Stem
- > Includes Reducer to accommodate 1.5" pole diameter

Item No.:

<b>BS700-2.0</b>	<b>Bronze</b>	
<b>BS709-2.0</b>	<b>Black</b>	

Shipping Information: Standard Parcel/Courier Services

Size	Weight	Cube	Pallet	MSRP
19"	70 lbs.	1.25	32	<b>\$320</b>

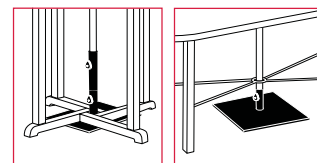
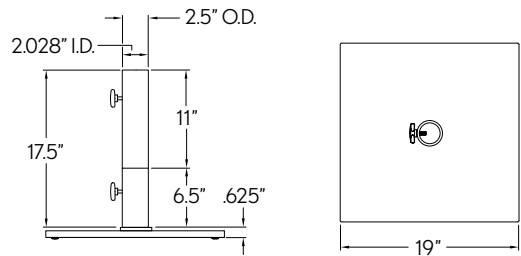

Under-the-table applications





**Shown:**

**Umbrella:**  
UM8000

7822 Mosaic Tile

**Base Option:**  
BG500

**Rug:**  
RG-614-686-35 (5'3" x 7'4")  
Sahara - Desert Sand

## Umbrella Lights

---

### EVO

Dual-Light Sound Pod

### Luna

Umbrella Light with Bluetooth®  
Speaker

### Halo

Umbrella Light

### Vega-L

Umbrella Light

#### **Shown:**

**Umbrella:**

UM8103

40434 Cast Slate

**Base Option:**

BA503

**Umbrella Light:**

EVO-03

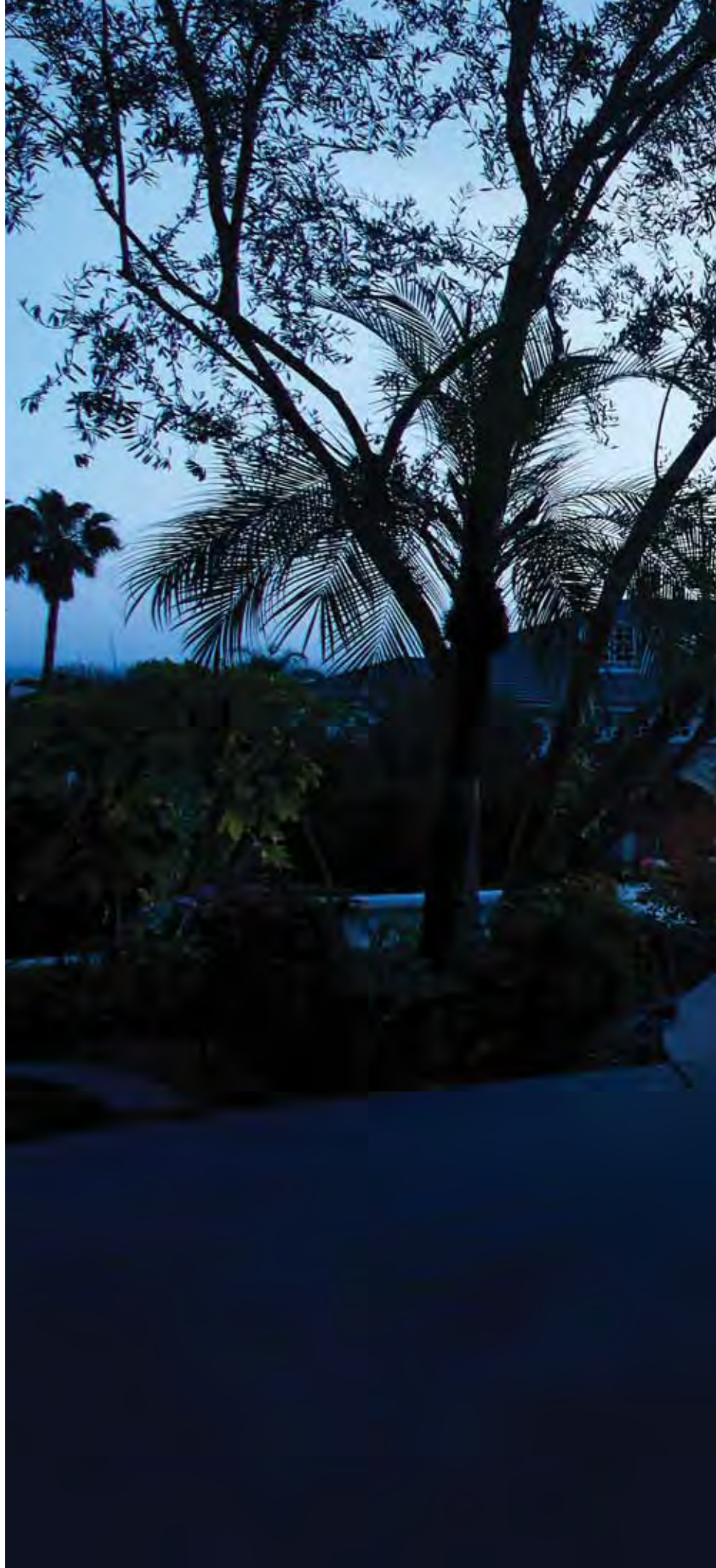



# UMBRELLA LIGHTS | Collection

## EVO Dual-Light Sound Pod



### Features:

- › 51 LED Lights
- › Up to 8 hours of battery life
- › Compatible with **Bluetooth®** devices
- › Umbrella light with self-adjusting clamp
- › Integrated bass speaker
- › Black unit comes with a warm light  
Color temperature: 2800K-3200K, 120 Lumen
- › White unit comes with a cool light  
Color temperature: 6000K-6700K, 120 Lumen
- › USB port to charge electronic devices (5V output)
- › Water and dust resistant
- › Power supply included

Item No.		Diameter	Weight	Cube	Case Pack	Case Weight	Case Cube	MSRP
<b>EVO-03</b>	White	8.68"	4.63 lbs.	0.72	4	31.97	3.3	<b>\$570</b>
<b>EVO-09</b>	Black							

The EVO dual-light sound pod is a multifunctional umbrella and table light with built in surround sound Bluetooth speakers, adding ambiance and entertainment to any outdoor setting. What makes this product truly special is that in addition to the integrated umbrella light with Bluetooth speakers, similar to our current Luna, it also includes a table light element and an integrated bass speaker that provides a crisp surround sound experience outdoors.

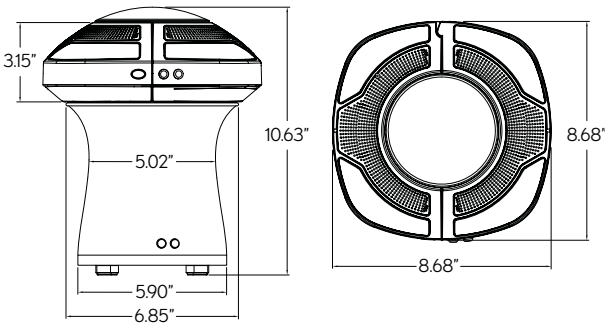

UMBRELLA LIGHTS

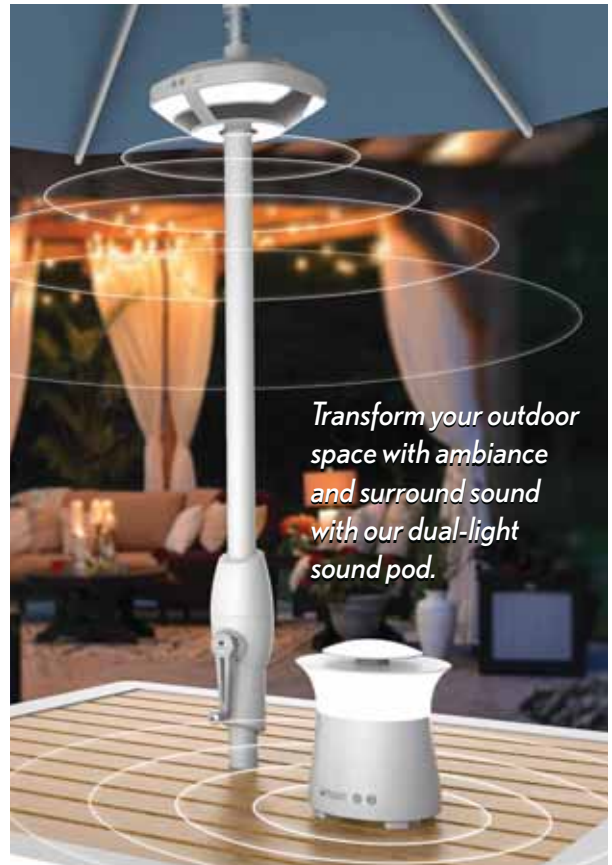

*Transform your outdoor space with ambiance and surround sound with our dual-light sound pod.*



## Luna

### Umbrella Light with Bluetooth® Speaker



**Features:**

- › 16 LED Lights
- › Up to 10 hours of battery life
- › Compatible with Bluetooth® devices
- › Color temperature: 6700k, 30 Lumen
- › Self-adjusting clamp
- › Power supply included



Item No.		Diameter	Weight	Cube	Case Pack	Case Weight	Case Cube	MSRP
<b>LUNA-00</b>	Bronze	9.76"	3 lbs.	0.3	6	19 lbs.	2	<b>\$220</b>
<b>LUNA-09</b>	Black							

The Luna turns your umbrella into its very own entertainment system. Share your favorite music with friends and family - it's perfect for parties or just relaxing. The Luna umbrella light with Bluetooth speaker illuminates and entertains.

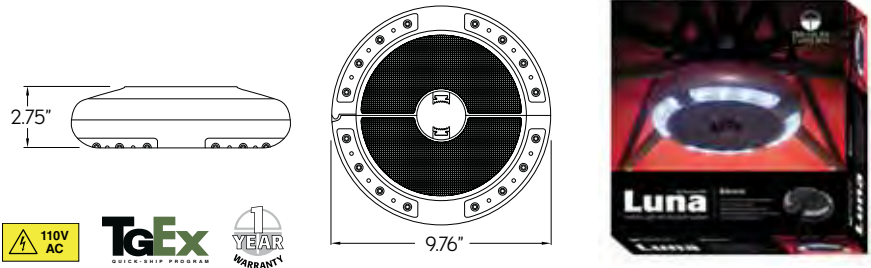

## Halo

### Umbrella Light

**Features:**

- › 26 LED Lights
- › Up to 6 hours of battery life
- › Color temperature: 4000k, 80 Lumen
- › Self-adjusting clamp
- › Rechargeable battery pack and power supply included



Item No.		Diameter	Weight	Cube	Case Pack	Case Weight	Case Cube	MSRP
<b>HALO-00</b>	Bronze	9.45"	3 lbs.	0.3	6	16 lbs.	1.7	<b>\$145</b>
<b>HALO-09</b>	Black							

The Halo is the evolution of the award-winning Vega light. Features the same user-friendly clamp on function, but with an upgraded modern design. Elevate your outdoor space with a Halo light to add ambiance with style.

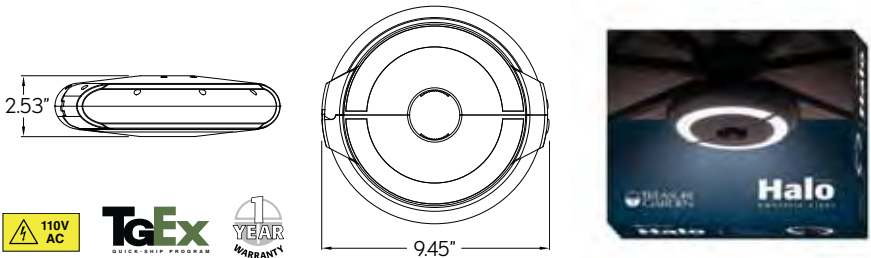

## Vega-L

### Umbrella Light

**Features:**

- › 36 LED Lights
- › Up to 6 hours of battery life
- › Color temperature: 6000k, 385 Lumen
- › Self-adjusting clamp
- › Rechargeable battery pack and power supply included



Item No.		Diameter	Weight	Cube	Case Pack	Case Weight	Case Cube	MSRP
<b>VEGA-L-00</b>	Bronze	9"	3 lbs.	0.31	6	16 lbs.	1.85	<b>\$135</b>
<b>VEGA-L-09</b>	Black							

The Vega-L "Large" umbrella light uses the same design as the award-winning Vega original; yet this larger model includes 50% more LED lights, with all the same patented features. Clamp adjusts to fit up to 2" patio umbrella poles.

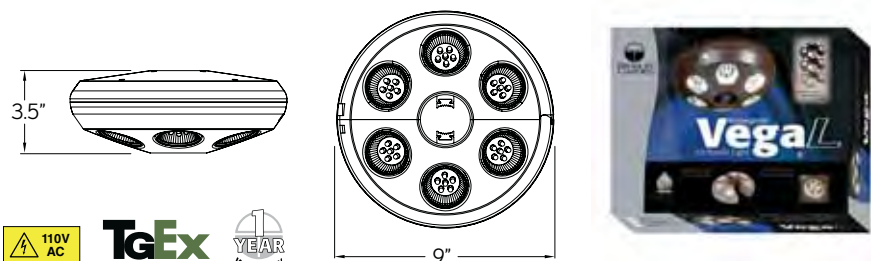

## Outdoor Rug

### GOLD

- Reflections - Ocean Blue
-  Moroccan - Sky Blue
- North Shore - Sky Blue
- Manhattan - Plush Gray
- Sahara - Desert Sand
- Canyon - Taupe
-  Prism - Taupe
- Savannah - Cottonwood
-  North Shore - Pebble
- Moroccan - Textured Taupe
- Ombré- Taupe
- Cobblestone - Gray
-  Painted Desert - Red
- Mosaic - Ruby
- Edge - Chili

### SILVER

- Geo - Black
- Athens - Silver
- Tuscan - Birch

**Shown:**

**Umbrella:**

UM8129D

40524-02 Trusted Coast Stripe

**Base Option:**

BW509/BW30

**Rug:**

RG-112-050-80 (7'10" x 10')

Manhattan - Plush Gray





# OUTDOOR RUG | Collection



- 2 Best Selling sizes available: 7'10" x 10' or 5'3" x 7'4"
- Easy to clean with mild soap
- 1-year Fade Warranty
- Made in Belgium



Shipping Information:  
 5'3" x 7'4" Standard Parcel/Courier Services  
 7'10" x 10' Truck Only (Oversized item, additional shipping costs will occur)

## The GOLD Collection

Our **GOLD** Collection includes on-trend designs combined with rich textures and vibrant colorations.

*Constructed with 100% Polypropylene multi-ply cabled heat-set yarns that offer a luxurious feel with excellent durability.*



## The SILVER Collection

Our exclusive and popular **SILVER** Collection is constructed of 100% Polypropylene yarns, in all-weather construction, that are stain & soil resistant with UV stabilizers to provide an excellent value.



OUTDOOR RUG

## Rug Tower Display

Item No.	Color	Size	Weight	Cube	MSRP
RTD-09	Black	25" W x 25" D x 53" H	67 lbs.	18.81	<b>\$1,415</b>

### Features:

- Displays up to (6) Treasure Garden Rugs
- (5) Polyurethane Wheels with (1) Locking Wheel
- Black - Powder Coated Steel
- Made in the USA



**Reflections - Ocean Blue**

Item No.	Size	Weight	Cube	MSRP
RG-334-369-80	7'10" x 10'	24 lbs.	2	<b>\$525</b>
RG-334-369-35	5'3" x 7'4"	12 lbs.	.93	<b>\$265</b>

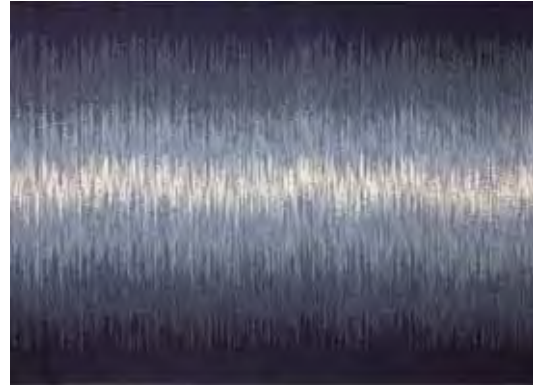

**Moroccan - Sky Blue** 

Item No.	Size	Weight	Cube	MSRP
RG-011-360-80	7'10" x 10'	24 lbs.	2	<b>\$525</b>
RG-011-360-35	5'3" x 7'4"	12 lbs.	.93	<b>\$265</b>



**North Shore - Sky Blue**

Item No.	Size	Weight	Cube	MSRP
RG-097-365-80	7'10" x 10'	24 lbs.	2	<b>\$525</b>
RG-097-365-35	5'3" x 7'4"	12 lbs.	.93	<b>\$265</b>



**Manhattan - Plush Gray**

Item No.	Size	Weight	Cube	MSRP
RG-112-050-80	7'10" x 10'	24 lbs.	2	<b>\$525</b>
RG-112-050-35	5'3" x 7'4"	12 lbs.	.93	<b>\$265</b>

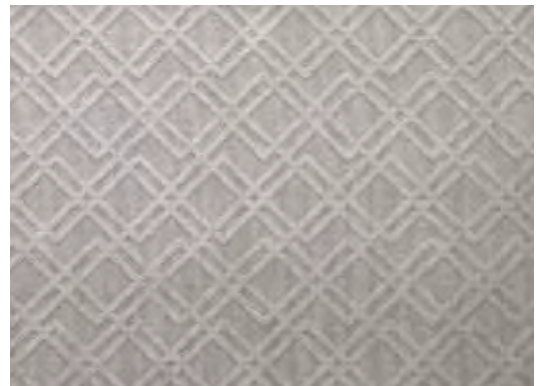

# OUTDOOR RUG | Collection

OUTDOOR RUG

## Sahara - Desert Sand

Item No.	Size	Weight	Cube	MSRP
RG-614-686-80	7'10" x 10'	24 lbs.	2	<b>\$525</b>
RG-614-686-35	5'3" x 7'4"	12 lbs.	.93	<b>\$265</b>



## Canyon - Taupe

Item No.	Size	Weight	Cube	MSRP
RG-203-651-80	7'10" x 10'	24 lbs.	2	<b>\$525</b>
RG-203-651-35	5'3" x 7'4"	12 lbs.	.93	<b>\$265</b>



## Prism - Taupe NEW

Item No.	Size	Weight	Cube	MSRP
RG-252-560-80	7'10" x 10'	24 lbs.	2	<b>\$525</b>
RG-252-560-35	5'3" x 7'4"	12 lbs.	.93	<b>\$265</b>



## Savannah - Cottonwood

Item No.	Size	Weight	Cube	MSRP
RG-431-363-80	7'10" x 10'	24 lbs.	2	<b>\$525</b>
RG-431-363-35	5'3" x 7'4"	12 lbs.	.93	<b>\$265</b>



**North Shore - Pebble** 

Item No.	Size	Weight	Cube	MSRP
RG-097-965-80	7'10" x 10'	24 lbs.	2	<b>\$525</b>
RG-097-965-35	5'3" x 7'4"	12 lbs.	.93	<b>\$265</b>

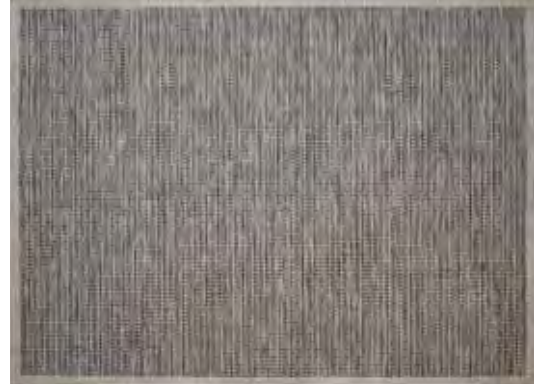

**Moroccan - Textured Taupe**

Item No.	Size	Weight	Cube	MSRP
RG-011-950-80	7'10" x 10'	24 lbs.	2	<b>\$525</b>
RG-011-950-35	5'3" x 7'4"	12 lbs.	.93	<b>\$265</b>



**Ombre - Taupe**

Item No.	Size	Weight	Cube	MSRP
RG-539-267-80	7'10" x 10'	24 lbs.	2	<b>\$525</b>
RG-539-267-35	5'3" x 7'4"	12 lbs.	.93	<b>\$265</b>



**Cobblestone - Gray**

Item No.	Size	Weight	Cube	MSRP
RG-461-388-80	7'10" x 10'	24 lbs.	2	<b>\$525</b>
RG-461-388-35	5'3" x 7'4"	12 lbs.	.93	<b>\$265</b>



# OUTDOOR RUG | Collection

## Painted Desert - Red NEW

Item No.	Size	Weight	Cube	MSRP
RG-075-014-80	7'10" x 10'	24 lbs.	2	<b>\$525</b>
RG-075-014-35	5'3" x 7'4"	12 lbs.	.93	<b>\$265</b>



## Mosaic - Ruby

Item No.	Size	Weight	Cube	MSRP
RG-284-175-80	7'10" x 10'	24 lbs.	2	<b>\$525</b>
RG-284-175-35	5'3" x 7'4"	12 lbs.	.93	<b>\$265</b>



## Edge - Chili

Item No.	Size	Weight	Cube	MSRP
RG-507-675-80	7'10" x 10'	24 lbs.	2	<b>\$525</b>
RG-507-675-35	5'3" x 7'4"	12 lbs.	.93	<b>\$265</b>





**Geo - Black**

Item No.	Size	Weight	Cube	MSRP
RS-404-993-80	7'10" x 10'	19 lbs.	2	<b>\$395</b>
RS-404-993-35	5'3" x 7'4"	10 lbs.	.93	<b>\$200</b>

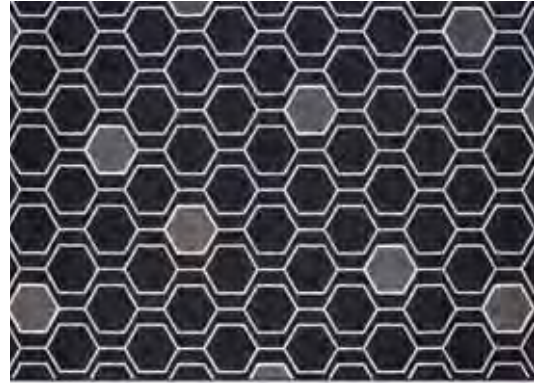

**Athens - Silver**

Item No.	Size	Weight	Cube	MSRP
RS-607-637-80	7'10" x 10'	21 lbs.	2	<b>\$395</b>
RS-607-637-35	5'3" x 7'4"	9 lbs.	.93	<b>\$200</b>



**Tuscan - Birch**

Item No.	Size	Weight	Cube	MSRP
RS-314-087-80	7'10" x 10'	21 lbs.	2	<b>\$395</b>
RS-314-087-35	5'3" x 7'4"	9 lbs.	.93	<b>\$200</b>

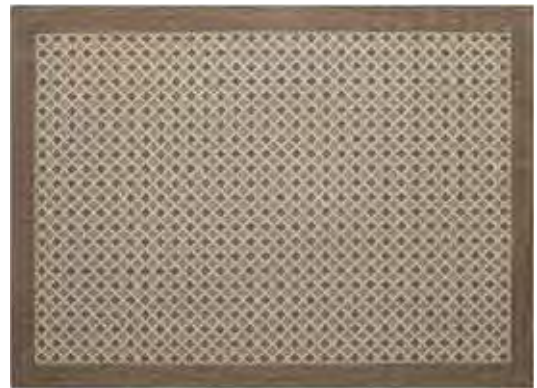



Protective Furniture Covers

Care and Maintenance Products

Replacement Canopy

Replacement Parts

TG CARE

**Shown:**

CP119S Small Chaise

CP922 Square Side Table

CP902 Large Umbrella







# Protective Furniture Covers

Protect your investment all year round.

The Treasure Garden Protective Furniture Covers are made with RhinoWeave<sup>®</sup>, a Treasure Garden exclusive. Designed to be durable, breathable, and water resistant and will not crack or peel like vinyl. All covers come with a one-year limited warranty.

## Furniture Covers features:

- Spring cinch lock to secure protective cover into place for a snug fit
- Convenient storage pouch sewn onto most covers
- Champagne Polyester 300D fabric
- UPF 50+



## How to measure for your protective furniture cover

**W = Width** is measured from the (widest point) from the right side to left side. **H = Height** is measured from the ground to the (highest point) of the piece.  
**D = Depth** is measured from front to back at its (deepest point). **Dia = Diameter** is measured from the (widest point) across the table top.



### Modular Outdoor

**(R)** Right End  
(Left Facing)

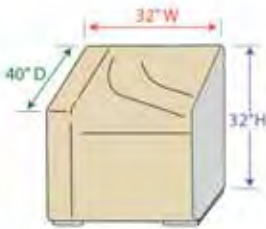

**(M)** Middle

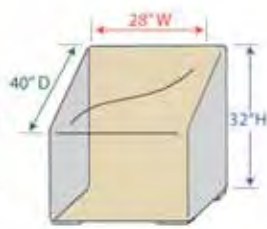

**(L)** Left End  
(Right Facing)

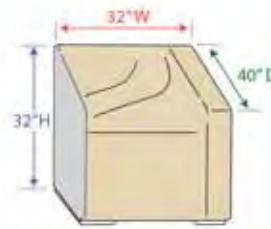

**(C)** Corner

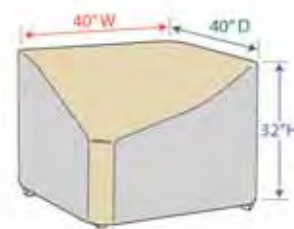

**(E)** Extension

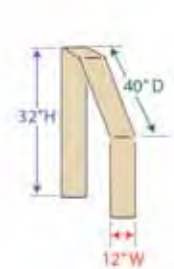

**(WR)** Wedge Right End  
(Left Facing)

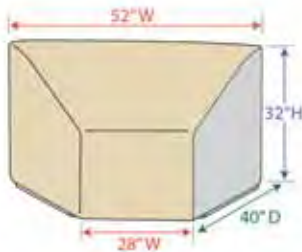

**(WC)** Wedge Center

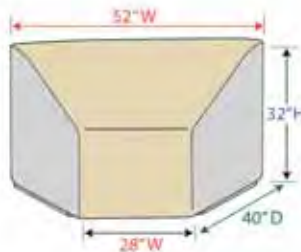

**(WL)** Wedge Left End  
(Right Facing)

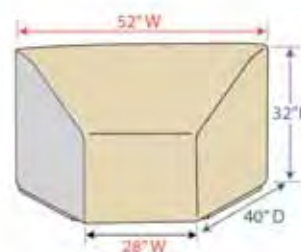

**NOTE:**

- Style codes for easy identification.
- Modular Extension style **(E)** allows greater flexibility for larger styles.
- Color ● = zipper side (OPEN)

## Modular Cover System

Our innovative modular cover system offers uniquely designed protective furniture covers to cover most modular styles. All styles can be joined together to cover the entire modular set, no matter what configuration.



The (8) modular covers are interchangeable and can be zipped together to create one complete unit.

### How to join styles together...

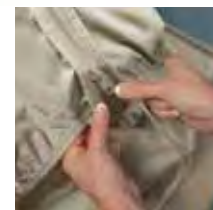

1. Zip covers together to desired configuration.



2. Cinch ties to secure covers to furniture.



# PROTECTIVE FURNITURE COVERS | TG Care

A Treasure Garden Exclusive  
**RhinoWeave® - Champagne**



DINING TABLES							
ITEM	ITEM NO.	DESCRIPTION	SIZE	WT (LBS)/CTN	CUBE/CTN	CASE PACK	MSRP (EACH)
	<b>CP531</b>	36" Round/Square Bistro Table & Chairs w/4 ties, elastic, spring cinch lock & storage pouch	48" Dia. x 25" H	24	1.97	8	<b>\$70</b>
	<b>CP551</b>	48" Round/Square Table & Chairs w/4 ties, elastic, spring cinch lock & storage pouch	84" Dia. x 36" H	26	1.97	4	<b>\$142</b>
	<b>CP571</b>	54" Round/Square Table & Chairs w/6 ties, elastic, spring cinch lock & storage pouch	92" Dia. x 36" H	28	1.97	4	<b>\$157</b>
	<b>CP590</b>	60" Round/Square Table & Chairs w/8 ties, elastic, spring cinch lock & storage pouch	108" Dia. x 36" H	35	2.42	4	<b>\$213</b>
	<b>CP586</b>	Small Oval/Rectangle Table & Chairs w/8 ties, elastic, spring cinch lock & storage pouch	60" W x 84" D x 36" H	23	1.97	4	<b>\$123</b>
	<b>CP584</b>	Medium Oval/Rectangle Table & Chairs w/8 ties, elastic, spring cinch lock & storage pouch	72" W x 102" D x 36" H	29	1.97	4	<b>\$153</b>
	<b>CP699</b>	Large Oval/Rectangle Table & Chairs w/8 ties, elastic, spring cinch lock & storage pouch	92" W x 128" D x 36" H	38	2.42	4	<b>\$200</b>
	<b>CP697</b>	X-Large Oval/Rectangle Table & Chairs w/8 ties, elastic, spring cinch lock & storage pouch	96" W x 180" D x 36" H	50	3.67	4	<b>\$266</b>

TG CARE

## How to use Storage Pouch

Protective furniture covers come with a sewn on storage pouch with the exception of umbrella, modular outdoor & fire pit styles.

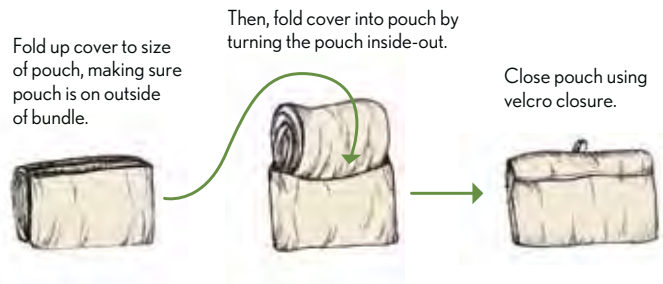

**Key:** W - Width / D - Depth / H - Height | **Dia.** - Diameter

**MODULAR OUTDOOR**

ITEM	ITEM NO.	DESCRIPTION	CODE	SIZE	WT (LBS)/CTN	CUBE/CTN	CASE PACK	MSRP (EACH)
	<b>CP401</b>	Modular Right End (Left Facing) Fits End Sectional w/elastic & spring cinch lock	<b>(R)</b>	32" W x 40" D x 32" H	19	1.61	8	<b>\$83</b>
	<b>CP402</b>	Modular Armless (Middle) Fits Middle Sectional w/elastic & spring cinch lock	<b>(M)</b>	28" W x 40" D x 32" H	15	1.00	8	<b>\$105</b>
	<b>CP403</b>	Modular Left End (Right Facing) Fits End Sectional w/elastic & spring cinch lock	<b>(L)</b>	32" W x 40" D x 32" H	18	1.61	8	<b>\$83</b>
	<b>CP404</b>	Modular Corner Fits Corner Sectional w/elastic & spring cinch lock	<b>(C)</b>	40" W x 40" D x 32" H	20	1.61	8	<b>\$119</b>
	<b>CP405</b>	Modular Extension Extends Sectionals w/elastic & spring cinch lock	<b>(E)</b>	12" W x 40" D x 32" H	9	1.00	8	<b>\$62</b>
	<b>CP406-R</b>	Modular Wedge Right End (Left Facing) Fits Wedge End Sectional w/elastic & spring cinch lock	<b>(WR)</b>	52" W x 40" D x 32" H (28" W - Front)	20	1.99	8	<b>\$105</b>
	<b>CP406-C</b>	Modular Wedge (Center) Fits Wedge Corner Sectional w/elastic & spring cinch lock	<b>(WC)</b>	52" W x 40" D x 32" H (28" W - Front)	18	1.23	8	<b>\$119</b>
	<b>CP406-L</b>	Modular Wedge Left End (Right Facing) Fits Wedge End Sectional w/elastic & spring cinch lock	<b>(WL)</b>	52" W x 40" D x 32" H (28" W - Front)	20	1.99	8	<b>\$105</b>

**CHAIRS & CHAISES**





ITEM	ITEM NO.	DESCRIPTION	SIZE	WT (LBS)/CTN	CUBE/CTN	CASE PACK	MSRP (EACH)
	<b>CP115</b>	Dining Chair w/elastic, spring cinch lock & storage pouch	28" W x 33" D x 35" H	25	1.82	10	<b>\$54</b>
	<b>CP116</b>	Counter Height Chair w/elastic, spring cinch lock & storage pouch	28" W x 33" D x 43" H	28	1.82	10	<b>\$62</b>
	<b>CP117</b>	Bar Height Chair w/elastic, spring cinch lock & storage pouch	28" W x 33" D x 49" H	31	2.42	10	<b>\$63</b>
	<b>CP119S</b>	Small Chaise w/4 ties, elastic, spring cinch lock & storage pouch	32" W x 80" D x 42" H (20" H - Front)	35	2.88	8	<b>\$91</b>
	<b>CP119L</b>	Large Chaise w/4 ties, elastic, spring cinch lock & storage pouch	36" W x 86" D x 42" H (20" H - Front)	29	2.42	6	<b>\$112</b>
	<b>CP130</b>	Double Chaise w/4 ties, elastic, spring cinch lock & storage pouch	61" W x 86" D x 42" H	35	2.88	6	<b>\$128</b>

**Key:** W - Width / D - Depth / H - Height | **Dia.** - Diameter



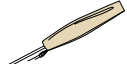
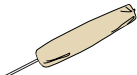

TG CARE

# PROTECTIVE FURNITURE COVERS | TG Care

## UMBRELLA COVERS

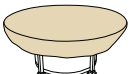
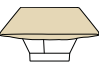

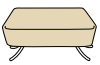
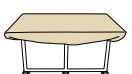
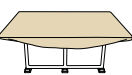

ITEM	ITEM NO.	DESCRIPTION	SIZE	WT (LBS)/CTN	CUBE/CTN	CASE PACK	MSRP (EACH)
	<b>CP901</b>	Umbrella (fits 6' to 8.5' market styles)	Fits (6', 7.5', 8.5') x 60" H	32	1.82	24	<b>\$36</b>
	<b>CP902</b>	Large Umbrella (fits 9' to 11' market styles)	Fits (9', 10', 11') x 72" H	36	1.82	24	<b>\$41</b>
	<b>CP910</b>	X-Large Umbrella (fits rectangle up to 10'x13')	Fits (8'x10', 8'x11', 13') x 110" H	41	1.82	16	<b>\$59</b>
	<b>CP912</b>	AG19 Cantilever style	Fits (8', 9', 10') x 88" H	47	2.02	24	<b>\$59</b>
	<b>CP908</b>	AG28 Cantilever style	Fits (10', 11') x 112" H	37	1.82	12	<b>\$74</b>
	<b>CP955</b>	AG25T Cantilever style	Fits (10', 11.5') x 98" H	38	1.82	16	<b>\$65</b>
	<b>CP920</b>	AKZP Cantilever style	Fits (10', 10'x13', 11', 13') x 104" H	31	1.82	12	<b>\$72</b>

## FIRE PITS, OTTOMANS & OCCASIONAL TABLES

ITEM	ITEM NO.	DESCRIPTION	SIZE	WT (LBS)/CTN	CUBE/CTN	CASE PACK	MSRP (EACH)
	<b>CP929</b>	Fits 36" to 42" Round Fire Pit/Table/Ottoman w/elastic, spring cinch lock & storage pouch	43" Dia. x 12" H	22	1.90	12	<b>\$60</b>
	<b>CP930</b>	Fits 48" to 54" Round Fire Pit/Table/Ottoman w/elastic, spring cinch lock & storage pouch	55" Dia. x 12" H	28	1.90	12	<b>\$66</b>
	<b>CP932</b>	Fits 42" to 48" Square Fire Pit/Table/Ottoman w/elastic, spring cinch lock & storage pouch	49" W x 49" D x 12" H	30	2.32	12	<b>\$74</b>
	<b>CP938</b>	Small Fire Pit/Table/Ottoman w/elastic, spring cinch lock & storage pouch	36" W x 30" D x 18" H	24	1.82	12	<b>\$46</b>
	<b>CP923</b>	Medium Rectangle Fire Pit/Table/Ottoman w/elastic, spring cinch lock & storage pouch	45" W x 30" D x 15" H	26	2.63	12	<b>\$59</b>
	<b>CP933</b>	Fits 50" x 30" Rectangle Fire Pit/Table/Ottoman w/elastic, spring cinch lock & storage pouch	51" W x 31" D x 12" H	34	1.90	12	<b>\$60</b>
	<b>CP936</b>	Fits 58" x 38" Rectangle Fire Pit/Table/Ottoman w/elastic, spring cinch lock & storage pouch	59" W x 39" D x 12" H	34	2.19	12	<b>\$74</b>
	<b>CP922</b>	Square Side Table w/elastic, spring cinch lock & storage pouch	27" W x 27" D x 15" H	20	1.90	12	<b>\$44</b>

Key: **W** - Width / **D** - Depth / **H** - Height | **Dia.** - Diameter

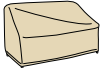
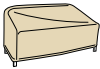
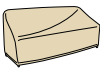
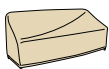
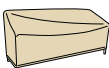

DEEP SEATING							
ITEM	ITEM NO.	DESCRIPTION	SIZE	WT (LBS)/CTN	CUBE/CTN	CASE PACK	MSRP (EACH)
	<b>CP711</b>	Lounge Chair w/elastic, spring cinch lock & storage pouch	33" W x 35" D x 35" H	33	2.88	12	<b>\$73</b>
	<b>CP712</b>	Large Lounge Chair w/elastic, spring cinch lock & storage pouch	36" W x 40" D x 35" H	25	1.82	8	<b>\$86</b>
	<b>CP741</b>	X-Large Lounge Chair w/elastic, spring cinch lock & storage pouch	43" W x 42" D x 43" H	22	1.82	6	<b>\$92</b>
	<b>CP720</b>	Loveseat w/elastic, spring cinch lock & storage pouch	50" W x 35" D x 35" H	21	1.82	6	<b>\$81</b>
	<b>CP722</b>	Large Loveseat w/elastic, spring cinch lock & storage pouch	60" W x 40" D x 35" H	32	2.42	8	<b>\$111</b>
	<b>CP742</b>	X-Large Loveseat w/elastic, spring cinch lock & storage pouch	69" W x 42" D x 43" H	28	2.42	6	<b>\$134</b>
	<b>CP723</b>	Sofa w/elastic, spring cinch lock & storage pouch	80" W x 35" D x 35" H	27	2.42	6	<b>\$124</b>
	<b>CP733</b>	Large Sofa w/elastic, spring cinch lock & storage pouch	85" W x 40" D x 35" H	29	2.42	6	<b>\$143</b>
	<b>CP743</b>	X-Large Sofa w/elastic, spring cinch lock & storage pouch	92" W x 42" D x 43" H	35	2.88	6	<b>\$154</b>



*Protect your outdoor furniture all year round.*

**Key:** W - Width / D - Depth / H - Height | Dia. - Diameter

# CARE AND MAINTENANCE PRODUCTS | TG Care

Our care line of products not only clean, maintain, protect and restore your outdoor furniture investment, but are also **safe for the environment**. All formulas are water-based, non-toxic, non-corrosive and completely free of solvents (VOC's).



**\*MUST ORDER IN CASE PACK QUANTITIES.**

## Upholstery & Fabric Products\*

Prolong the life of your umbrella and outdoor furniture fabric with a regular cleaning (at least once a season). After cleaning, we recommend to treat furniture fabric with our Fabric & Upholstery Protector before outdoor exposure.

### Upholstery & Fabric Cleaner

- Cleaner removes dirt and restores the new look of fabrics, textiles & upholstery.
- For cushions, seatings and umbrellas.



**Item No.:**  
**TGC-UFC-32**

**Specifications:**

**Weight** 32 oz.

**Case Pk** 12

**MSRP: \$28 ea.**

### Mold & Mildew Stain Remover

- Easy to use formula allows you to simply spray and rinse clean.
- Quickly dissolves mold and mildew stains.



**Item No.:**  
**TGC-MMR-32**

**Specifications:**

**Weight** 32 oz.

**Case Pk** 12

**MSRP: \$32 ea.**

### Upholstery & Fabric Protector

- Helps to prevent stains.
- Maintains the new look.
- Makes fabrics, textiles & upholstery repellent to dirt, water and moisture.



**Item No.:**  
**TGC-UFP-32**

**Specifications:**

**Weight** 32 oz.

**Case Pk** 12

**MSRP: \$52 ea.**

## Outdoor Furniture Products\*

Keep your outdoor furniture looking like new – from umbrellas, dining furniture to chaise lounges.

### Multi Surface Cleaner

- Removes dirt, grease, oil and pollutants from wicker, textile, resin & stone surfaces.



**Item No.:**  
**TGC-MSC-32**

**Specifications:**

**Weight** 32 oz.

**Case Pk** 12

**MSRP: \$28 ea.**

### Textilene® & Wicker Protector

- Protector contains a plasticizer substance to maintain the flexibility of the wicker resin and extends the lifetime of the furniture.



**Item No.:**  
**TGC-WTP-32**

**Specifications:**

**Weight** 32 oz.

**Case Pk** 12

**MSRP: \$39 ea.**

### Stainless Steel/Cast Aluminum/ Cast Iron Cleaner & Guard

- Fast acting and easy to use. Cleans and protects in one treatment.
- Helps to prevent and remove corrosion.



**Item No.:**  
**TGC-MSP-16**

**Specifications:**

**Weight** 16 oz.

**Case Pk** 12

**MSRP: \$30 ea.**

## Teak & other Hardwoods\*

Clean, restore and protect your indoor and outdoor teak & hardwood and make your furniture look fresh and new again.

### Teak Cleaner & Color Restorer

- Cleans and restores discolored dark grey teak and hardwood.
- Non-hazardous.



**Item No.:**  
**TGC-TWC-16**

**Specifications:**

**Weight** 16 oz.

**Case Pk** 12

**MSRP: \$24 ea.**

### Teak Sealer (Brown)

- Maintain the honey-brown color of teak for a longer period of time.
- Prevents black spots.
- Non-greasy.



**Item No.:**  
**TGC-TBS-16**

**Specifications:**

**Weight** 16 oz.

**Case Pk** 12

**MSRP: \$39 ea.**

### Teak Protector (Transparent)

- Helps to prevent stains while keeping the natural look of the surface.
- Built-in mold and mildew inhibitor.



**Item No.:**  
**TGC-TTP-16**

**Specifications:**

**Weight** 16 oz.

**Case Pk** 12

**MSRP: \$42 ea.**

## Application Tools\*

### Eco-Friendly



Safe for the environment.

### Scrubbing Pads (2 pack)

For cleaning upholstery & fabrics, teak and other outdoor furniture materials.  
MADE OF 100% POLYESTER FIBERS



**Item No.:**  
**TGC-SP-2PK**

**Specifications:**

**Weight** 1 oz.

**Case Pk** 10

**MSRP: \$9 ea.**

### Application Cloths (3 pack)

For applying cleaner & guard, sealer and protectors.  
MADE OF 80% VISCOSE  
20% POLYPROPYLENE



**Item No.:**  
**TGC-AC-3PK**

**Specifications:**

**Weight** 1.5 oz.

**Case Pk** 12

**MSRP: \$9 ea.**

## Merchandising

### Display

Showcase the TG Care - Cleaning & Maintenance products in an eye-popping branded display.

**Item No.:**

**TGC-001**

**MSRP: \$70 ea.**

Products not included.



## Paint

### Touch Up Paint

Our 4.5 oz. aerosol spray for hassle-free and mess-free touch up of scratches on aluminum frames and bases.

**Color:**

- Bronze
- Champagne
- Anthracite
- White
- Black
- Platinum

**Item No.:**

- Touchup-BRZ**
- Touchup-CHAMP**
- Touchup-ANTHR**
- Touchup-WHT**
- Touchup-BLK**
- Touchup-5T**



**Specifications:**

**Weight** 4.5 oz.

**Case Pk** 12

**MSRP: \$32 ea.**

## Cantilever

STYLE	ITEM NO.	GRADE	VENTS	MSRP
AKZP13 AKZP13LX 13' Octagon	<b>C813RD</b>	A+ A C/COM+	DWV DWV DWV	\$2,310 \$1,445 \$1,190
AKZP13 AKZP13LX 13' Octagon	<b>C813RDV</b>	A+ A C/COM+	DWV w/Valance DWV w/Valance DWV w/Valance	\$2,450 \$1,615 \$1,310
AKZPRT 10'x13' Rectangle	<b>CAKZRT</b>	A+ A C/COM+	SWV SWV SWV	\$2,310 \$1,370 \$1,180
AKZPSQ11 11.5' Square	<b>C812SQ</b>	A+ A C/COM+	SWV SWV SWV	\$2,300 \$1,360 \$1,170
AKZPSQ11 11.5' Square	<b>C812SQV</b>	A+ A C/COM+	SWV w/Valance SWV w/Valance SWV w/Valance	\$2,440 \$1,600 \$1,295
AG28RK AKZP 11' Octagon	<b>C811RD</b>	A+ A C/COM+	DWV DWV DWV	\$1,870 \$1,175 \$765
AG28RK AKZP 11' Octagon	<b>C811RDV</b>	A+ A C/COM+	DWV w/Valance DWV w/Valance DWV w/Valance	\$2,020 \$1,290 \$860
AG25TR 11.5' Octagon	<b>CAG25DR</b>	A+ A C/COM+	DWV DWV DWV	\$1,890 \$1,395 \$870
AG25TR 11.5' Octagon	<b>CAG25DRV</b>	A+ A C/COM+	DWV w/Valance DWV w/Valance DWV w/Valance	\$2,095 \$1,650 \$1,005
AG25TSQR 10' Square	<b>CAG25SQR</b>	A+ A C/COM+	SWV SWV SWV	\$1,760 \$1,290 \$780
AG25TSQR 10' Square	<b>CAG25SQRV</b>	A+ A C/COM+	SWV w/Valance SWV w/Valance SWV w/Valance	\$1,970 \$1,540 \$915
AG19 10' Octagon	<b>CAG19</b>	A+ A C/COM+	SWV SWV SWV	\$1,065 \$665 \$335





## Specialty

STYLE	ITEM NO.	GRADE	VENTS	MSRP
Vienna Alu Teak 11' Octagon (NO TRIM)	<b>C8911</b>	A+ A C/COM+	SWV SWV SWV	\$1,090 \$960 \$585
Vienna Alu Teak 11' Octagon (TRIM)	<b>C8911T</b>	A	SWV	\$960
Pagoda 9' Hexadecagon	<b>C654</b>	A	SWV	\$715

## Market & Wood

STYLE	ITEM NO.	GRADE	VENTS	MSRP
11' - SWV For UM801, UM812	<b>C811</b>	A+ A C/COM+	SWV SWV SWV	\$970 \$625 \$410
11' - DWV For UM801, UM812	<b>C811D</b>	A+ A C/COM+	DWV DWV DWV	\$1,025 \$700 \$455
9' - SWV For UM800, UM800LX, UM8091, UM810, UM970, UM920	<b>C809</b>	A+ A C/COM+	SWV SWV SWV	\$585 \$410 \$215
9' - DWV For UM800, UM800LX, UM8091, UM810, UM970, UM920	<b>C809D</b>	A+ A C/COM+	DWV DWV DWV	\$635 \$450 \$255
7.5' - SWV For UM977, UM907	<b>C807</b>	A+ A C/COM+	SWV SWV SWV	\$415 \$305 \$175
8'x11' Rectangle For UM8811RT	<b>C8811</b>	A+ A C/COM+	SWV SWV SWV	\$715 \$555 \$320
8'x10' Rectangle For UM8810RT	<b>C8810</b>	A+ A C/COM+	SWV SWV SWV	\$690 \$510 \$285

**Commercial**

STYLE	ITEM NO.	GRADE	VENTS	MSRP
UCP409 9' Octagon	<b>C809</b>	A+* A/  Opbravia Awning Grade C/COM†	SWV SWV SWV	\$585 \$410 \$215
UCP409 9' Octagon	<b>C809V</b>	A+* A/  Opbravia Awning Grade C/COM†	SWV w/Valance SWV w/Valance SWV w/Valance	\$695 \$505 \$295
UCP409 9' Octagon	<b>C809D</b>	A+* A/  Opbravia Awning Grade C/COM†	DWV DWV DWV	\$635 \$450 \$255
UCP409 9' Octagon	<b>C809DV</b>	A+* A/  Opbravia Awning Grade C/COM†	DWV w/Valance DWV w/Valance DWV w/Valance	\$740 \$715 \$545
UCP407SQ 7' Square	<b>C407SQ</b>	A+* A/  Opbravia Awning Grade C/COM†	SWV SWV SWV	\$505 \$355 \$185
UCP407SQ 7' Square	<b>C407SQV</b>	A+* A/  Opbravia Awning Grade C/COM†	SWV w/Valance SWV w/Valance SWV w/Valance	\$655 \$485 \$265

**Vents:**  
SWV - Single Wind Vent  
DWV - Double Wind Vent

**Vents with Valance:**  
SWV w/Valance - Single Wind Vent with Valance  
DWV w/Valance - Double Wind Vent with Valance

\*  Sunbrella Awning Grade available at a 20% upcharge.

**NOTE:** When ordering a REPLACEMENT CANOPY, simply add the Fabric No. after the Replacement Canopy Item No.

**EXAMPLE:**

Canopy Style needed: UCP409 - 9' Octagon

Fabric: 5404 Natural

REPLACEMENT CANOPY ITEM NO.: C809-5404

†COM - Customer's Own Material. For COM, see page 139.

**Replacement Parts**

Replacement parts are available for most umbrellas in frame finishes\* listed in the 2022 TG catalog. Refer to specific product pages for parts availability and/or TeamTG for replacement parts lists. Orders must be faxed or emailed and include Item No., year purchased and description of the specific part needed.

**NO PHONE ORDERS PLEASE**

WHEN PLACING ANY ORDERS FOR REPLACEMENT CANOPY OR PARTS - FAX YOUR REQUEST TO (888) 821-8868 OR EMAIL: [order@treasuregarden.com](mailto:order@treasuregarden.com)

\*NOTE: WE DO NOT STOCK REPLACEMENT PARTS IN FINISHES THAT ARE NOT STOCKED DOMESTICALLY FOR PRODUCTS ORDERED THROUGH OUR TG DIRECT - EARLY BUY CONTAINER PROGRAM.

REPLACEMENT FRAMES		ITEM NO.	FRAME	ITEM NO.	FRAME
		AKZP13LX-0_	\$1,735	UM800_LX	\$730
		AKZP13-0_	\$1,505	UM812_	\$330
		AKZPRT-0_	\$1,595	UM810_	\$315
		AKZPSQ11-0_	\$1,460	UM8810RTO_	\$415
		AKZP-0_	\$1,350	UM8811RTO_	\$390
		AG25TR-0_	\$915	UM970_	\$185
		AG25TSQR-0_	\$930	UM977_	\$165
		AG28RK-0_	\$960	UM920_	\$165
		AG19-0_	\$675	UM907_	\$145
		UV89115A	\$845	UM8091	\$205
		USA459	\$275	UCP409-0_	\$360
		UM801_	\$400	UCP407SQ-0_	\$320
		UM800_	\$360		
REPLACEMENT BOTTOM POLES		ITEM NO.	BP32-800_	BP36-801_	BP45-800_
		USA459	\$27	\$27	\$34
		UM801_		\$27	\$34
		UM800_	\$27	\$27	\$34
		ITEM NO.	BP32-800_LX	BP45-800_LX	
		UM800_LXR	\$64	\$75	
		ITEM NO.	BP32-810_	BP36-812_	BP45-810_
		UM812_		\$27	\$34
		UM810_	\$27	\$27	\$34
		UM8810RTO_	\$27	\$27	\$34
		UM970_	\$27	\$27	\$34
		UM977_	\$27	\$27	\$34
		ITEM NO.	BP41-8811RTO_	BP45-810_	
		UM8811RTO_	\$34	\$34	
		ITEM NO.	BP32-920_	BP36-907_	BP45-920_
		UM920_	\$27	\$27	\$34
		UM907_		\$27	\$34
		ITEM NO.	BP36-8091		
		UM8091	\$27		

## Merchandising For Success

---

Designer Canopy Collection

Merchandise Display Stands

Science Behind Shade



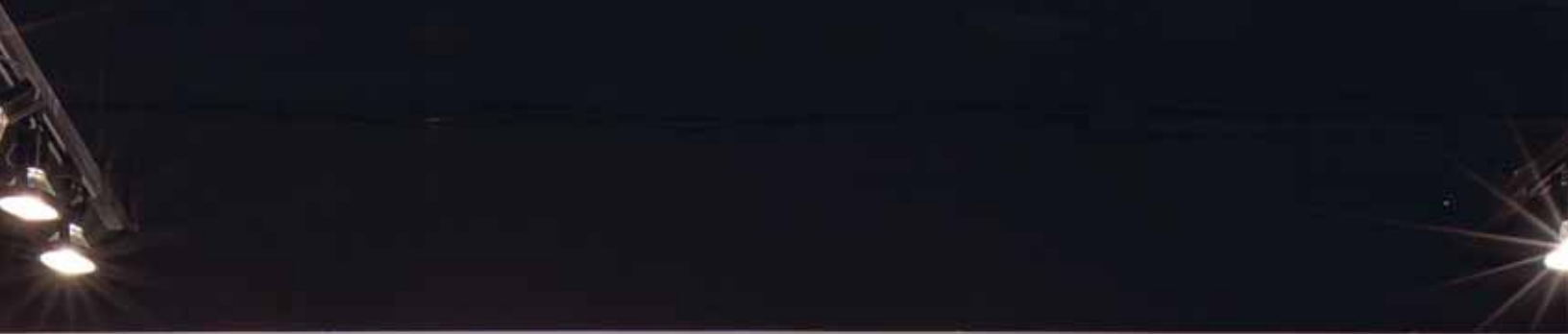

o'bravia

The Science Behind Color



The Science Behind Thread

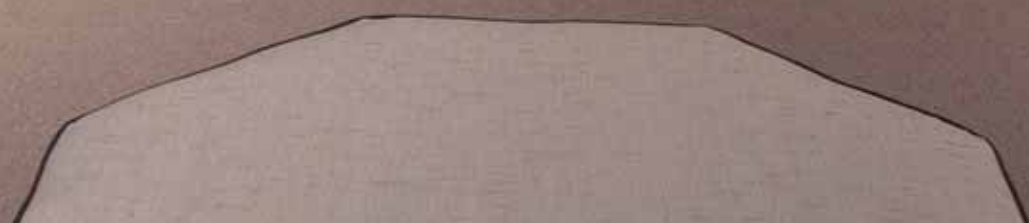

# DESIGNER CANOPY COLLECTION | Merchandising For Success

Available on 13' and 11' cantilevers & 11' and 9' market umbrellas.  
Offered in 100% Solution-Dyed Acrylic and Polyester fabrics.

## How to Order:

### 1. SELECT YOUR DC ITEM NO.

- See DC sample styles below

### 2. SELECT YOUR FABRIC(S)

- Go to the Treasure Garden Fabric Collection pages or refer to our Swatch Book for fabric selections.

### 3. SIMPLY ADD:

- The DC Item No. to your desired umbrella Item No.

## Ordering Information:

To ensure the proper sewing of your custom umbrella, please list EACH individual fabric number in the sequence you wish them to appear from **top vent to trim/valance** (starting from the center finial and working towards the canopy trim/valance).

**Note:** You cannot mix fabric grades.

NO RETURNS ON CUSTOM OR DESIGNER CANOPY STYLE UMBRELLAS.

**Double Wind Vent pricing applies to all Designer Canopy (DC) styles.**

## 11' and 9' Market Umbrellas - Designer Canopy Designs

### Item No.: DC4

#### Sandwich (DWV ONLY)

Specify 2 fabrics

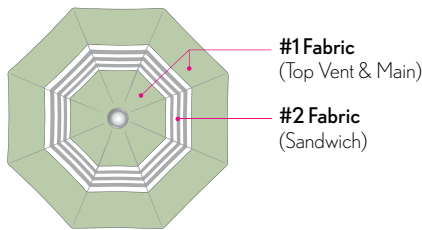

### Item No.: DC5

#### Three Fabrics (DWV ONLY)

Specify 3 fabrics

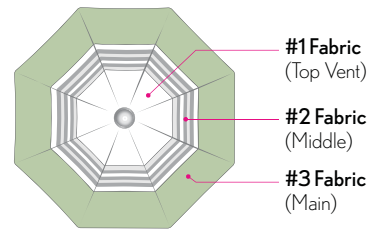

### Item No.: DC6

#### Trim Accent (SWV ONLY)

Specify 2 fabrics

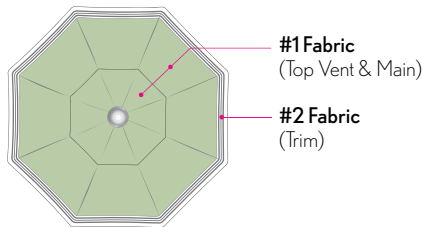

### Item No.: DC7

#### Top Vent and Trim Accent (SWV ONLY)

Specify 2 fabrics

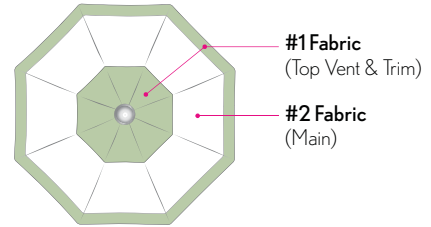

## 13' and 11' Cantilever Umbrellas - Designer Canopy Designs

### Item No.: DC9

#### Top Vent and Valance Accent

Specify 2 fabrics

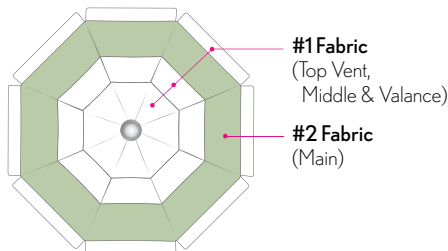

### Item No.: DC11

#### Sandwich

Specify 2 fabrics

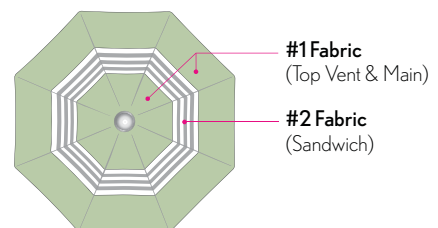



Merchandising For Success | **DESIGNER CANOPY COLLECTION**

DC's NOT available on AKZPRT, AKZPSQ11, AG19, AG25T & AG25TSQ Cantilevers, Specialties, 7.5' Glide Tilt, 7.5' Push Button Tilt, 8'x10' Auto Tilt, 8'x11' Crank Lift and 7' Commercial styles.



UM8009  
6447/6664

**DC4**



**6447**  
Surf

**6664**  
Churchill Beach  
Stripe



UM8009  
5404/6433/54048

**DC5**



**5404**  
Natural

**6433**  
Neptune

**54048**  
Charcoal



UM8002  
6664/54048

**DC6**

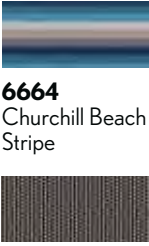

**6664**  
Churchill Beach  
Stripe

**54048**  
Charcoal



UM8103  
5453/6664

**DC7**

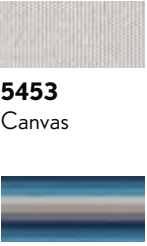

**5453**  
Canvas

**6664**  
Churchill Beach  
Stripe



AKZP13-09DV  
5422/6664

**DC9**

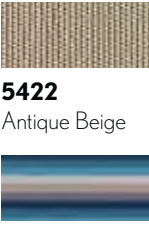

**5422**  
Antique Beige

**6664**  
Churchill Beach  
Stripe



AKZP-09D  
6433/6664

**DC11**

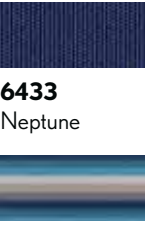

**6433**  
Neptune

**6664**  
Churchill Beach  
Stripe

MERCHANDISING

# RUG TOWER DISPLAY STAND | Merchandising For Success

The innovative and best way to merchandise and sell rugs!



MERCHANDISING



### Features:

- Displays up to (6) Treasure Garden Rugs
- (5) Polyurethane Wheels with (1) Locking Wheel
- Black - Powder Coated Steel
- Made in the USA



**Item No.:**  
**RTD-09**

### Specifications:

**Size** 25" W x 25" D x 53" H  
**Color** Black  
**Weight** 67  
**Cube** 18.81

**MSRP: \$1,415**

# Umbrella Display Stand



**Item No.:**  
**BD609**

Crossbar displays (6) umbrellas

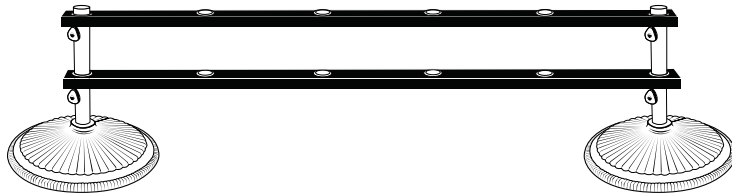

**Specifications:**

**Size** 72" W x 3" D  
(2) Crossbars

**Color** Black

**Weight** 25 lbs.

**Cube** 0.81

**MSRP: \$100**

Crossbars install onto Treasure Garden's BA509, BG509, BW509 and BKM1009 black bases (Sold separately).

## Mini Umbrella Display

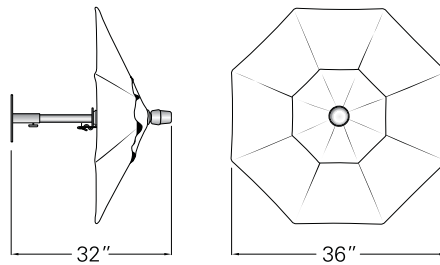

**Specifications:**

**Umbrella Size** 36"

**Height** 32"

**Shape** Octagon

**Wall Bracket** Included

**Weight** 9 lbs.

**Cube** 0.65

**Carton Size** 28" x 7" x 7"



**Single Fabric Display:**

Includes canopy, frame/finial and wall bracket.

**Example:** 4801 Cobalt **Item No.:** MU-4801

**Item No.:**

**MU-** \_\_\_\_\_  
Fabric No.

**MSRP:**

**\$155**

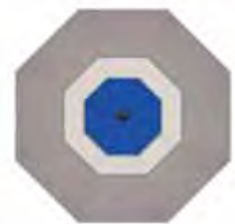

**CANOPY ONLY Single Fabric:**

**Example:** 4801 Cobalt **Item No.:** CMINI-4801

**CMINI-** \_\_\_\_\_  
Fabric No.

**\$100**

**Designer Canopy Fabric Display:**

Includes Designer Canopy, frame/finial and wall bracket.

**Example:** DC5 - 4801 Cobalt/4853 Vanilla/4820 Boulder

**Item No.:** MDC005-4801/4853/4820

**MDC00** \_\_\_\_ - \_\_\_\_ / \_\_\_\_ / \_\_\_\_  
DC# Fabric Nos.

**\$155**

**CANOPY ONLY Designer Canopy Fabric:**

**Example:** DC5 - 4801 Cobalt/4853 Vanilla/4820 Boulder

**Item No.:** CMINI5-4801/4853/4820

**CMINI** \_\_\_\_ - \_\_\_\_ / \_\_\_\_ / \_\_\_\_  
DC# Fabric Nos.

**\$100**



MERCHANDISING







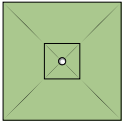
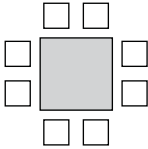
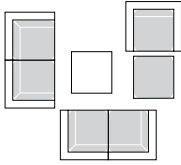

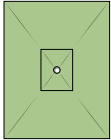
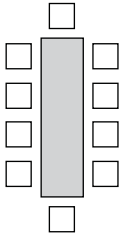
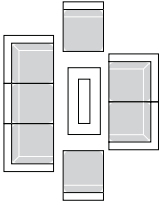
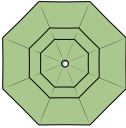
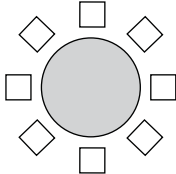
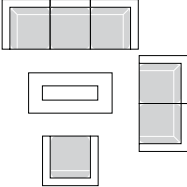
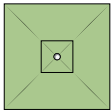
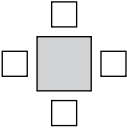
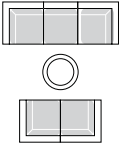
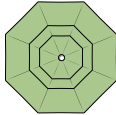
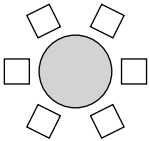
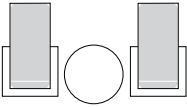
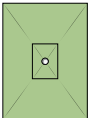
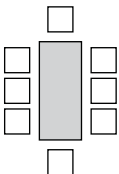
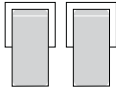
# SCIENCE BEHIND SHADE | Merchandising For Success

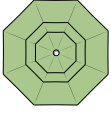
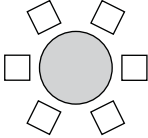
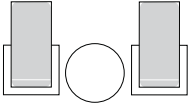
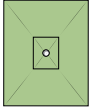
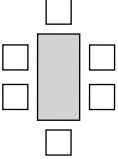
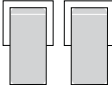
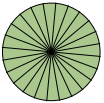
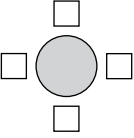
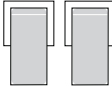
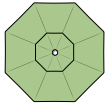
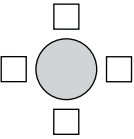
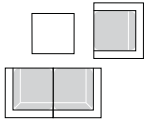
Solar radiation can dramatically change the temperatures of an object that it hits, heating it far above the actual air temperature. The proper shade over your dining or deep seating areas can reduce the temperature up to **20%**.

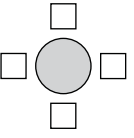
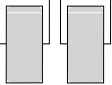
A **sweltering 95°** can become a **comfortable 80°** with the proper shade!

**NOTE:**  
□ Suggested RUG size  
■ Suggested TABLE size

SIZE/SHAPE	DINING	DEEP SEATING*	STYLE
<b>11.5' Square</b>  <b>132</b> <i>sq. ft. coverage</i>	<span style="color: blue;">■</span> 60" to 84" square table 		11.5' AKZ Plus Cantilever  <span style="color: orange;">□</span> 7'10" x 10' Rug
<b>10'x13' Rectangle</b>  <b>130</b> <i>sq. ft. coverage</i>	<span style="color: blue;">■</span> 84" to 108" rectangle table 		10'x13' AKZ Plus Cantilever <span style="color: orange;">□</span> 7'10" x 10' Rug
<b>13' Octagon</b>  <b>129</b> <i>sq. ft. coverage</i>	<span style="color: blue;">■</span> 70" + round table 		13' Starlux AKZ Plus Cantilever 13' AKZ Plus Cantilever <span style="color: orange;">□</span> 7'10" x 10' Rug
<b>10' Square</b>  <b>100</b> <i>sq. ft. coverage</i>	<span style="color: blue;">■</span> 48" to 54" square table 		10' AG25TSQ Cantilever <span style="color: orange;">□</span> 7'10" x 10' Rug
<b>11.5' Octagon</b>  <b>96</b> <i>sq. ft. coverage</i>	<span style="color: blue;">■</span> 60" + round table 		11.5' AG25T Cantilever <span style="color: orange;">□</span> 7'10" x 10' Rug
<b>8'x11' Rectangle</b>  <b>88</b> <i>sq. ft. coverage</i>	<span style="color: blue;">■</span> 72" to 84" rectangle table 		8'x11' Crank Lift <span style="color: orange;">□</span> 7'10" x 10' Rug

SIZE/SHAPE	DINING	DEEP SEATING*	STYLE
<b>11' Octagon</b>  <b>85</b> sq. ft. coverage	■ 60" + round table 		11' Vienna Alu Teak 11' AKZ Plus Cantilever 11' AG28 Cantilever 11' Collar Tilt 11' Auto Tilt □ 7'10" x 10' Rug
<b>8'x10' Rectangle</b>  <b>80</b> sq. ft. coverage	■ 48" to 60" rectangle table 		8'x10' Auto Tilt □ 7'10" x 10' Rug
<b>10' Round</b>  <b>70</b> sq. ft. coverage	■ 48" to 54" round table 		10' Shanghai Collar Tilt □ 5'3" x 7'4" Rug
<b>10' Octagon</b>  <b>70</b> sq. ft. coverage	■ 48" to 54" round table 		10' AG19 Cantilever □ 7'10" x 10' Rug
<b>9' Octagon</b>  <b>57</b> sq. ft. coverage	■ 48" to 54" round table 		9' Starlux Collar Tilt 9' Collar Tilt 9' Auto Tilt 9' Glide Tilt 9' Push Button Tilt 9' Quad Pulley Lift 9' Commercial □ 5'3" x 7'4" Rug □ 7'10" x 10' Rug
<b>7' Square</b>  <b>49</b> sq. ft. coverage	■ 30" to 36" cafe/bistro 		7' Commercial □ 5'3" x 7'4" Rug
<b>7.5' Octagon</b>  <b>39</b> sq. ft. coverage	■ 30" to 36" cafe/bistro 		7.5' Glide Tilt 7.5' Push Button Tilt □ 5'3" x 7'4" Rug

\*Suggested Deep Seating arrangements can vary based on actual individual piece dimensions.



## Sales Programs

**TG Custom -**  
Domestic Custom-Made Umbrellas

**TG Direct -**  
Direct Container Program

**TGEx Program -**  
Quick-Ship Program

**CQS Program -**  
Cantilever Quick-Ship Program

The **TG CUSTOM Program** features the finest residential and commercial umbrellas from Treasure Garden, Shademaker and Jardinico. We offer your choice of hundreds of quality fabrics from the top U.S. mills; as well as our exclusive  **Oravia** fabrics. All umbrella frames/finishes & accessories featured in the 2022 catalog are available to ship from Baldwin Park, CA.

### DOMESTIC CUSTOM-MADE UMBRELLAS

Create extraordinary umbrellas with thousands of possible fabric combinations for 2022; the program includes our exclusive **Designer Canopy Collection** at the standard DWV price.

#### **In-Stock Fabrics:**

Lead time is 6-8 weeks for Treasure Garden, Shademaker and Jardinico from Baldwin Park, CA. Please note that this lead time is based on capacity and material availability and is subject to change throughout the season.

#### **Non-Stock Fabrics:**

Lead time is 8-10 weeks for Treasure Garden, Shademaker and Jardinico from Baldwin Park, CA. Please note that this lead time is based on capacity and material availability and is subject to change throughout the season. Awning grade fabrics will incur a 20% upcharge.

#### **Full Roll:**

Full roll orders will be honored at the standard pricing.  
Note: Certain mills may have a minimum yardage requirement.

#### **Less Than a Full Roll:**

For orders of less than 1 roll, a 10% upcharge will incur and will require longer lead times.

#### **All Non-Stock Striped Fabrics:**

Need to be ordered in **pairs**, due to cutting requirements.

Contact your Customer Service Representative for availability and specific lead times.

### FABRICS BY THE YARD

GRADE	MSRP
A	\$85

MAXIMUM QUANTITY: 10 yards



Our **DIRECT Container Program** simplifies the process of shipping large quantities of goods anywhere. Give us your quantity breakdown and final destination point, we'll take care of the rest.

## DIRECT CONTAINER PROGRAM

### Direct Container Order Guidelines:

All TG 2022 program frame colors combined with TGD fabrics are available to ship from Ningbo, China.

### Chinese New Year: February 1, 2022

Chinese New Year holiday is January 31, 2022 - February 6, 2022. Last day before CNY shipment is January 14, 2022 and the 1st week of shipment after CNY is week of February 21, 2022.

Market Conditions can affect production lead times as well as shipment dates. We will make every effort to ship containers as requested however all containers will be scheduled on a first come/first serve basis. Our import office will alert you as soon as possible as to your scheduled shipment date(s).

### Production Lead Time:

Allow 12-20 weeks\*. Contact your TG Sales or Customer Service Representative for orders requiring shorter lead times.

### Transit Time:

Allow 6-10 weeks\* depending on current market conditions. Containers can arrive as fast as 4 weeks to the West Coast and take up to 10 weeks to the East Coast.

\*Please note that this lead time is based on capacity and material availability and is subject to change throughout the season.

### Payment Terms:

1. Irrevocable At Sight Letter of Credit at order acknowledgement  
or
2. Wire transfer 21 days prior to scheduled ship date

### FOB:

All container orders from Ningbo, China ship Freight Collect. The dealer is responsible for all freight charges - both sea and land, insurance fees, broker fees, bank fees for L/C or wire transfers and additional handling fees.

### Freight Forwarder:

- You may select your own or we will use ours.
- If selecting your own - Must provide Forwarders Name & Contact Information

### Bill Of Lading:

- Must choose Original or Telex Release
- If Telex Release is chosen, a payment must be made at the time it's requested to avoid any delays.

### PLEASE NOTE YOUR CHOICES ON YOUR ORDER.

The purchase of a container may also involve bank charges and other charges unrelated to the price of the product including but not limited to duties, storage, shipping and transportation charges, third party inspection charges whether inspected at point of origin, point of entry or point of delivery.

\*Contact your TG Sales or Customer Service Representative for any questions regarding specific lead times.

## TG DIRECT - DUTY SCHEDULE

Complete Umbrellas	6.975%
Umbrella Bases	5.675%
Protective Covers	7.475% (+7.5% on List 4A)
Umbrella Frames only	12.475%
Umbrella Lights	4.375% (+25% - Tariff 301)

### Duty:

All products manufactured by Treasure Garden Inc., incur duties to the USA. This is a tax imposed by our Federal government. Unfortunately, we are not duty free.

Dealer is responsible for all duties for container goods before container arrives at destination.

### Estimated overall Freight & Duties

(13-16%) Depending on your location and product assortment.

### In-Season Order Guidelines:

All frame colors combined with TGD fabrics are available to ship from Ningbo, China.

### In-Season Production Lead Time:

Allow 4-8 weeks\*. However, we may be able to ship as quickly as 2 weeks depending on production schedules.

**Note:** Special order frame/base colors will require longer lead times.

### In-Season Transit Time:

Allow 4-7 weeks\*. Containers can arrive as fast as 3 weeks to the West Coast and take as long as 6 weeks to the East Coast.

**Note:** The Direct Container Program is not available for In-season reorder from Baldwin Park, CA. It is imperative to forecast your entire seasons needs on your container order for any special frame styles.

**Replacement Parts:** We DO NOT stock replacement parts for items that are TG Direct Only. If you are ordering TG Direct Only items, **we recommend ordering additional replacement parts with your container order.** Your TG Sales or Customer Service Representative can assist you with suggestions on how to place an order.



**TGEEx "Quick-Ship"** program is available in select awning grade fabrics on our Shademaker 8'2" Libra styles and select furniture grade on our 7.5' and 9' Single Wind Vent (**SWV**) & 11' Double Wind Vent (**DWV**) Treasure Garden market umbrellas.

NOTE: **DO NOT COMBINE NON-TGEEx** fabrics on your TGEEx order. For all other fabrics available (NON-TGEEx), see pages **44-47**

**Program is available year-round & ships within 5 BUSINESS DAYS\* in the continental U.S.**

\*NOTE: Shipping may be delayed due to possible fabric shortage.

## LIBRA

**8'2" LIBRA-25 Octagon**  
**8'2" LIBRA-25S Square**  
 (see page 99)

See pages **110-112** for Libra Base/Mount options. (sold separately)

**VALANCE OPTION NOT AVAILABLE.**



Available frame finish:



Silver Shadow

**sunbrella** Awning Grade 100% Solution-Dyed Acrylic



**4601**  
Pacific Blue



**4604**  
Natural



**4608**  
Black



**4644**  
Charcoal



**4666**  
Logo Red



**4677**  
Tuscan

## MARKET UMBRELLAS

**sunbrella** Grade A 100% Solution-Dyed Acrylic



**5401**  
Pacific Blue



**5403**  
Jockey Red



**5404**  
Natural



**5407**  
Henna



**5408**  
Black

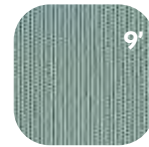

**5413**  
Spa



**5422**  
Antique Beige

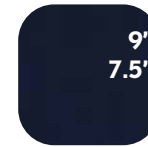

**5439**  
Navy



**5446**  
Forest Green



**5453**  
Canvas



**5476**  
Heather Beige



**40433**  
Cast Silver

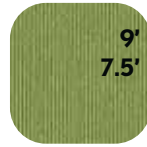

**54011**  
Ginkgo

**o'bravia** Grade C 100% Solution-Dyed Polyester



**4801**  
Cobalt



**4803**  
Red



**4807**  
Auburn



**4808**  
Black



**4811**  
Kiwi

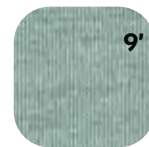

**4813**  
Spa



**4815**  
Sunset

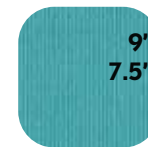

**4816**  
Aqua



**4818**  
Sesame



**4820**  
Boulder



**4822**  
Khaki



**4826**  
Sky



**4838**  
Lemon

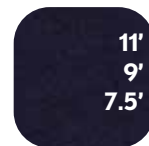

**4839**  
Navy



**4846**  
Forest Green

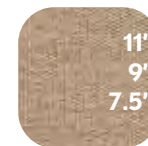

**4876**  
Sand



## ACCESSORIES



The TGEEx "Quick-Ship" Program also includes the following accessories:

- Outdoor rugs
- Treasure Garden, Shademaker and Jardinico umbrella bases & mount kits
- Umbrella lights
- Protective furniture covers
- Care and maintenance products
- Replacement canopies within TGEEx and CQS programs
- Jardinico accessories



**NOTE:** Dealers who place a single purchase order without specifying a specific program, the order will automatically be shipped out at the longer lead time based on the items ordered. Dealers who want separate shipments with different lead times (i.e. - TGEEx and TGCUSTOM), please write separate purchase orders per program and make sure correct items are offered in those programs. Dealers who place a single purchase order specifying multiple or incorrect programs based on items ordered, the order will automatically be split-shipped separately according to their respective programs.

*Program is available year-round & ships within 7 BUSINESS DAYS\* in the continental U.S*

SALES PROGRAMS

## CANTILEVERS

### AKZ Plus Cantilevers:

- 13' AKZP13 (see page 7)
- 10'x13' AKZPRT (see page 8)
- 11.5' AKZP11SQ (see page 9)
- 11' AKZP (see page 10)

### Available frame finish:

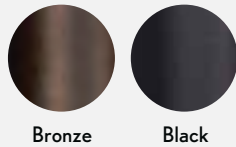

### AG Cantilever:

- 11' AG28 (see page 16)

### Available frame finish:

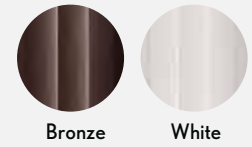

See pages 18-19 for Cantilever Base/Mount options. (sold separately)

**VALANCE OPTION NOT AVAILABLE.**



See page 18 for Cantilever Base option. (sold separately)

**VALANCE OPTION NOT AVAILABLE.**

**NOTE:** To ensure your cantilever "Quick-Ship" order is processed without delay. Orders must be placed on a separate P.O. and marked "Cantilever Quick-Ship".



**Grade A**  
100% Solution-Dyed  
Acrylic



- 5403 Jockey Red
- 5404 Natural
- 5407 Henna
- 5439 Navy
- 5476 Heather Beige
- 40433 Cast Silver



**Grade C**  
100% Solution-Dyed  
Polyester

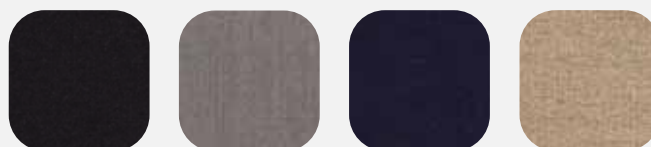

- 4808 Black
- 4820 Boulder
- 4839 Navy
- 4876 Sand

All fabrics shown are not to scale. Patterns, textures and colors may vary slightly from actual fabric; please refer to the Treasure Garden fabric swatch book for samples.

# TABLE OF CONTENTS

<b>LIBRA CENTERPOST</b> 6' 6" LIBRA-20S 8' 2" LIBRA-25 8' 2" LIBRA-25S	98-99
<b>ASTRAL-TC CENTERPOST</b> 11' 5" ASTRAL-TC-35S 13' 1" ASTRAL-TC-40S 16' 4" ASTRAL-TC-50 16' 4" ASTRAL-TC-50S	100-101
<b>SIRIUS SIDEPOST</b> 8' 9" SR-27S 9' 9" SR-30 9' 9" SR-30S 11' 5" SR-35	102-103
<b>POLARIS SIDEPOST</b> 9' 9" POLARIS-30S 11' 5" POLARIS-35S 10'x13' POLARIS-340RT 13' 1" POLARIS-40 13' 1" POLARIS-40S	104-105
<b>ORION SIDEPOST</b> 8' 9" OR-27S 9' 9" OR-30 9' 9" OR-30S 13' 1" OR-40	106-107
<b>GALAXY SIDEPOST</b> 11' 5" GALAXY-35S 13' 1" GALAXY-40S 16' 4" GALAXY-50	108-109
 <b>MOUNT &amp; BASES OPTIONS</b>	110-112
<b>BASE WEIGHT MATRIX</b>	113
<b>REPLACEMENT PARTS &amp; OPTIONS</b>	114-115
<b>FABRICS &amp; FRAME FINISHES</b>	116-117
<b>TERMS &amp; CONDITIONS</b>	134-136
<b>WARRANTY / GUARANTEE</b>	138





**shademaker**  
architectural shade

SHOWN: LIBRA-25S in 58033 Shore Classic





# LIBRA



**Features:**

- Easy push-up and automatic locking system
- Internal counterweight to close with ease
- Durable high performance hub and fittings
- External mast stem for mount kit and steel base weight options
- Includes protective cover

**TGEx**  
TECHNOLOGICAL GROUPS, INC.  
 (see pg. 94)

Item No.	Size		Canopy Shape	Coverage	Ribs			Min. Base Weight*
	meters	feet						
<b>LIBRA-20S</b>	2.0m	6' 6"	Square	43 sq. ft.	4	7' 8"	3' 1"	100 lbs.
<b>LIBRA-25</b>	2.5m	8' 2"	Octagon	52 sq. ft.	8	7' 8"	3' 7"	100 lbs.
<b>LIBRA-25S</b>	2.5m	8' 2"	Square	67 sq. ft.	8	8'	2' 2"	100 lbs.

\* NOTE: Recommended minimum weight requirements for free-standing applications.

See page **117** for **Frame Finish Options**

**MOUNT OPTIONS/BASES:**

See page **110** for concrete and in-ground mounting options

See page **111** for steel base weights & base options

See page **112** for steel and cast aluminum bases

Item No.	MSRP <b>Price Group 1</b> <small>Sunbrella® Awning Grade</small>	MSRP <b>Price Group 2</b> <small>O'bravia® Awning Grade Sunbrella®/Outdura®/Bliss Furniture Grade</small>
<b>LIBRA-20S</b>	<b>\$1,090</b>	<b>\$855</b>
<b>LIBRA-25</b>	<b>\$1,360</b>	<b>\$1,095</b>
<b>LIBRA-25S</b>	<b>\$1,425</b>	<b>\$1,165</b>

NOTE: Oversized - Additional shipping cost for this style.

**Striped fabrics must be ordered in pairs,  
 due to cutting requirements.**

– Visit [www.shademakerusa.com](http://www.shademakerusa.com) for more product information –

SHOWN: ASTRAL-TC-40S in 5816 Aqua



# ASTRAL-TC



**Features:**

- Telescopic mast
- Effortless crank lift system
- Removable crank handle
- Durable high performance hub and fittings
- Galvanized internal mast stem
- Includes internal mast stem cover
- Includes protective cover

Item No.	Size		Canopy Shape	Coverage	Ribs				Min. Base Weight*
	meters	feet							
<b>ASTRAL-TC-35S</b>	3.5m	11' 5"	Square	131 sq. ft.	8	9' 2"	11' 5"	3' 4"	400 lbs.
<b>ASTRAL-TC-40S</b>	4.0m	13' 1"	Square	172 sq. ft.	8	9' 4"	12'	2' 11"	500 lbs.
<b>ASTRAL-TC-50</b>	5.0m	16' 4"	Octagon	210 sq. ft.	8	9' 2"	12' 3"	3' 4"	600 lbs.**
<b>ASTRAL-TC-50S</b>	5.0m	16' 4"	Square	266 sq. ft.	8	9' 6"	13' 3"	1' 8"	700 lbs.**

\* NOTE: Recommended minimum weight requirements for free-standing applications.

\*\* Permanent mount recommended. See page 110  
Available in Silver Shadow frame finish only.

**MOUNT OPTIONS/BASES:**

See page 110 for concrete and in-ground mounting options  
See page 111 for steel base weights & base options

**Striped fabrics must be ordered in pairs, due to cutting requirements.**

Item No.	MSRP Price Group 1 <i>Sunbrella® Awning Grade</i>	MSRP Price Group 2 <i>O'bravia® Awning Grade Sunbrella®/Outdura®/Bliss Furniture Grade</i>
<b>ASTRAL-TC-35S</b>	<b>\$4,900</b>	<b>\$3,915</b>
<b>ASTRAL-TC-40S</b>	<b>\$5,585</b>	<b>\$4,465</b>
<b>ASTRAL-TC-50</b>	<b>\$5,835</b>	<b>\$4,675</b>
<b>ASTRAL-TC-50S</b>	<b>\$6,735</b>	<b>\$5,395</b>

SHOWN: SR-27S-AW (Arctic White) in 5816 Aqua





# SIRIUS



**Features:**

- 3 front to back tilt positions
- 8 locking positions with 360° rotation
- Simple to operate crank lift system
- Removable crank handle
- Built-in light adapter
- Durable high performance hub and fittings
- Stainless steel hardware for longevity
- Galvanized internal mast stem
- Includes internal mast stem cover
- Includes protective cover

**(3) front to back tilt positions**

Item No.	Size		Canopy Shape	Coverage	Ribs				Min. Base Weight*
	meters	feet							
<b>SR-27S</b>	2.7m	8' 9"	Square	77 sq. ft.	8	8' 5"	8' 9"	13' 9"	350 lbs.
<b>SR-30</b>	3.0m	9' 9"	Octagon	75 sq. ft.	8	8' 5"	8' 11"	12' 5"	350 lbs.
<b>SR-30S</b>	3.0m	9' 9"	Square	95 sq. ft.	8	8' 5"	9'	14' 7"	350 lbs.
<b>SR-35</b>	3.5m	11' 5"	Octagon	103 sq. ft.	8	8' 5"	8' 11"	12' 11"	450 lbs.

\* NOTE: Recommended minimum weight requirements for free-standing applications.

See page **117** for **Frame Finish Options**

**MOUNT OPTIONS/BASES:**

See page **110** for concrete and in-ground mounting options

See page **111** for steel base weights & base options

Item No.	MSRP Price Group 1 <i>Sunbrella® Awning Grade</i>	MSRP Price Group 2 <i>O'bravia® Awning Grade Sunbrella®/Outdura®/Bliss Furniture Grade</i>
<b>SR-27S</b>	<b>\$3,715</b>	<b>\$2,975</b>
<b>SR-30</b>	<b>\$3,570</b>	<b>\$2,875</b>
<b>SR-30S</b>	<b>\$4,125</b>	<b>\$3,310</b>
<b>SR-35</b>	<b>\$4,010</b>	<b>\$3,200</b>

**Striped fabrics must be ordered in pairs, due to cutting requirements.**

SHOWN: POLARIS-30S in 4677 Tuscan



# POLARIS



**Features:**

- Simple to operate infinite front to back tilt system
- 8 locking positions with 360° rotation
- Built-in light adapter
- Durable high performance hub and fittings
- Stainless steel hardware for longevity
- Galvanized internal mast stem
- Includes internal mast stem cover
- Includes protective cover

**Infinite front to back tilt system.**

Item No.	Size		Canopy Shape	Coverage	Ribs				Min. Base Weight*
	meters	feet							
<b>POLARIS-30S</b>	3.0m	9' 9"	Square	95 sq. ft.	8	8' 8"	9' 2"	13' 1"	450 lbs.
<b>POLARIS-35S</b>	3.5m	11' 5"	Square	131 sq. ft.	8	9' 3"	9' 5"	13' 10"	550 lbs.
<b>POLARIS-340RT</b>	3.0m x 4.0m	10' x 13'	Rectangle	130 sq. ft.	8	9' 2"	9' 6"	13'	550 lbs.
<b>POLARIS-40</b>	4.0m	13' 1"	Octagon	134 sq. ft.	8	9' 4"	9' 7"	15' 1"	700 lbs.**
<b>POLARIS-40S</b>	4.0m	13' 1"	Square	172 sq. ft.	8	9' 8"	9' 6"	15' 3"	700 lbs.**

\* NOTE: Recommended minimum weight requirements for free-standing applications.

\*\* Permanent mount recommended. See page 110  
See page 117 for **Frame Finish Options**

**MOUNT OPTIONS/BASES:**

See page 110 for concrete and in-ground mounting options  
See page 111 for steel base weights & base options

**Striped fabrics must be ordered in pairs, due to cutting requirements.**

NOTE: Striped fabrics not available on POLARIS-340RT

Item No.	MSRP Price Group 1 <i>Sunbrella® Awning Grade</i>	MSRP Price Group 2 <i>O'bravia® Awning Grade Sunbrella®/Outdura®/Bliss Furniture Grade</i>
<b>POLARIS-30S</b>	<b>\$4,760</b>	<b>\$3,810</b>
<b>POLARIS-35S</b>	<b>\$5,395</b>	<b>\$4,315</b>
<b>POLARIS-340RT</b>	<b>\$5,545</b>	<b>\$4,495</b>
<b>POLARIS-40</b>	<b>\$5,430</b>	<b>\$4,390</b>
<b>POLARIS-40S</b>	<b>\$5,980</b>	<b>\$4,785</b>

SHOWN: OR-27S in 5804 Eggshell





# ORION



### Features:

- Canopy structure easily detaches for storage
- 8 locking positions with 360° rotation
- Simple to operate crank lift system
- Removable crank handle
- Built-in light adapter
- High-grade stainless steel cable
- Durable high performance hub and fittings
- Galvanized internal mast stem
- Includes internal mast stem cover
- Includes protective cover

Item No.	Size		Canopy Shape	Coverage	Ribs			Min. Base Weight*
	meters	feet						
<b>OR-27S</b>	2.7m	8' 9"	Square	77 sq. ft.	8	9' 3"	2' 4"	350 lbs.
<b>OR-30</b>	3.0m	9' 9"	Octagon	75 sq. ft.	8	8' 11"	3' 6"	350 lbs.
<b>OR-30S</b>	3.0m	9' 9"	Square	95 sq. ft.	8	9' 7"	1' 9"	350 lbs.
<b>OR-40</b>	4.0m	13' 1"	Octagon	134 sq. ft.	8	9' 10"	2' 6"	500 lbs.

\* NOTE: Recommended minimum weight requirements for free-standing applications.

See page **117** for **Frame Finish Options**

### MOUNT OPTIONS/BASES:

See page **110** for concrete and in-ground mounting options

See page **111** for steel base weights & base options

Item No.	MSRP Price Group 1 <i>Sunbrella® Awning Grade</i>	MSRP Price Group 2 <i>O'bravia® Awning Grade Sunbrella®/Outdura®/Bliss Furniture Grade</i>
<b>OR-27S</b>	<b>\$4,330</b>	<b>\$3,465</b>
<b>OR-30</b>	<b>\$4,290</b>	<b>\$3,425</b>
<b>OR-30S</b>	<b>\$4,500</b>	<b>\$3,605</b>
<b>OR-40</b>	<b>\$5,170</b>	<b>\$4,135</b>

**Striped fabrics must be ordered in pairs,  
due to cutting requirements.**

– Visit [www.shademakerusa.com](http://www.shademakerusa.com) for more product information –

SHOWN: GALAXY-35S in 4608 Black





# GALAXY



**Features:**

- Superior in design and durability
- Durable high performance hub and fittings
- Includes protective cover

**NOTE: It is imperative that the eight (8) spacer buttons (white plastic cups/screws) are installed after the canopy is opened for the first time. Warranty will be voided if spacer buttons are not installed properly.**

Item No.	Size		Canopy Shape	Coverage	Ribs			Min. Base Weight
	meters	feet						
<b>GALAXY-35S</b>	3.5m	11' 5"	Square	131 sq. ft.	8	10' 1"	1' 4"	Mount
<b>GALAXY-40S</b>	4.0m	13' 1"	Square	172 sq. ft.	8	9' 10"	9"	Mount
<b>GALAXY-50</b>	5.0m	16' 4"	Octagon	210 sq. ft.	8	10' 2"	1' 2"	Mount

See page 117 for **Frame Finish Options**

**MOUNT OPTIONS:**

See page 110 for concrete and in-ground mounting options.

Item No.	<b>MSRP Price Group 1</b> <i>Sunbrella® Awning Grade</i>	<b>MSRP Price Group 2</b> <i>O'bravia® Awning Grade Sunbrella®/Outdura®/Bliss Furniture Grade</i>
<b>GALAXY-35S</b>	<b>\$7,610</b>	<b>\$6,080</b>
<b>GALAXY-40S</b>	<b>\$8,610</b>	<b>\$6,885</b>
<b>GALAXY-50</b>	<b>\$9,080</b>	<b>\$7,255</b>

**Striped fabrics must be ordered in pairs, due to cutting requirements.**

# mount options

All Shademaker styles are designed to be mounted. Our Mount Kits (concrete and in-ground applications) are the recommended and preferred method to properly secure your umbrella.

## mount kits for libra styles

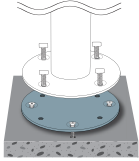

Item No.	Description	Plate Dia.	Thickness	Weight	Cube	MSRP
<b>MKC21</b>	concrete mount kit	8.46"	.47"	6.84 lbs.	.05	<b>\$215</b>
		<b>CASE PACK</b>	<b>CASE WEIGHT</b>	<b>CASE CUBE</b>		
		10	83 lbs.	.46		

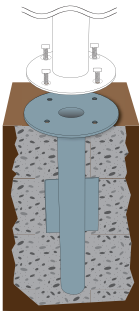

Item No.	Description	Plate Dia.	Thickness	Weight	Cube	MSRP
<b>MKG21</b>	in-ground mount kit	8.39"	.39"	11.69 lbs.	1.08	<b>\$165</b>
		Stem Dia: 2.38" Depth: 19.6"		<b>CASE PACK</b>	<b>CASE WEIGHT</b>	<b>CASE CUBE</b>
				4	59 lbs.	4.33

## mount kits for astral-tc, sirius, polaris and orion styles

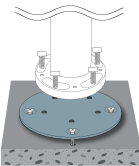

Item No.	Description	Plate Dia.	Thickness	Weight	Cube	MSRP
<b>MKC17</b>	concrete mount kit	8.5"	.63"	9.04 lbs.	.08	<b>\$230</b>
		<b>CASE PACK</b>	<b>CASE WEIGHT</b>	<b>CASE CUBE</b>		
		5	51 lbs.	.39		

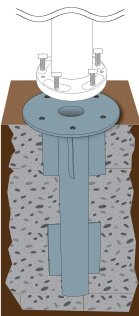

Item No.	Description	Plate Dia.	Thickness	Weight	Cube	MSRP
<b>MKG17</b>	in-ground mount kit	6.3"	.38"	10.04 lbs.	.70	<b>\$185</b>
		Stem Dia: 2.38" Depth: 19.53"		<b>CASE PACK</b>	<b>CASE WEIGHT</b>	<b>CASE CUBE</b>
				2	23 lbs.	1.4

## mount kits for galaxy styles

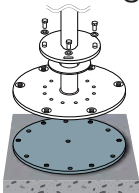

Item No.	Description	Plate Dia.	Thickness	Weight	Cube	MSRP
<b>GMKC21</b>	concrete mount kit	15.125"	.64"	22.05 lbs.	.38	<b>\$485</b>

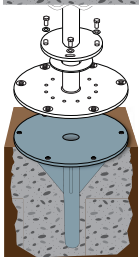

Item No.	Description	Plate Dia.	Thickness	Weight	Cube	MSRP
<b>GMKG21</b>	in-ground mount kit	15.75"	.63"	48.51 lbs.	4.33	<b>\$465</b>

Stem Dia: 2.7"  
Depth: 18.75"



# steel base weights & base

Shademaker steel base weights may be purchased individually or in multiple sizes and stacked to meet base weight requirements.

## steel base weights for libra styles



Item No.	Weight	Size	Thickness	MSRP
<b>SB50SQ*</b>	50 lbs.	17"	.675"	<b>\$300</b>
<b>SB100SQ</b>	100 lbs.	24"	.675"	<b>\$490</b>
<b>SB125SQ</b>	125 lbs.	27"	.675"	<b>\$630</b>



Item No.	Weight	Size	Thickness	MSRP
<b>SB50R*</b>	50 lbs.	19"	.675"	<b>\$370</b>
<b>SB100R</b>	100 lbs.	27"	.675"	<b>\$590</b>
<b>SB125R</b>	125 lbs.	30"	.675"	<b>\$730</b>

steel base weight  
(stacked) combinations



**\*NOTE:** When stacking steel base weights, the **SB50R** and **SB50SQ** CAN ONLY BE USED AS THE TOP WEIGHT (1) STACKED.

**300 lbs.:** (2) SB125SQ + (1) SB50SQ (shown)

## geomet steel base weight for astral-tc, sirius, polaris and orion styles

**NOTE: SM PLATE (Adapter Plate) REQUIRED.**



Item No.	Weight	Size	Thickness	MSRP
<b>SBGC100SQ</b>	100 lbs.	26"	.6"	<b>\$1,150</b>
<b>SBGC200SQ</b>	200 lbs.	36"	.6"	<b>\$1,820</b>



(SM) adapter plate;  
geomet steel base weight

Item No.	Weight	Size	Thickness	MSRP
<b>SM PLATE</b>	8 lbs.	8.5"	.6"	<b>\$85</b>

## titan base | galvanized steel frame + aluminum lid

for astral-tc, sirius, polaris and orion styles

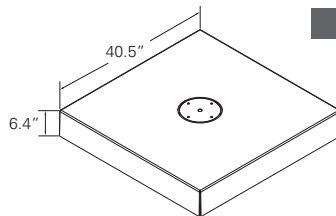

**NOTE: SM PLATE (Adapter Plate) REQUIRED.**



Accommodates (32)  
12"x12"x1.5" pavers  
(not included)

Item No.	Size	Cube	Weight	Total Weight with Pavers	Stone/Steel plate details (Sold separately)	MSRP
<b>BGT850-SG</b>	40.5" x 6.4"	10.79	118.1 lbs.	850 lbs.	Holds up to 32 pavers	<b>\$2,035</b>

# additional bases for libra

## steel base w/casters

Item No.	Finish	Weight	Cube	Pallet	MSRP
<b>BSK1200</b>	bronze	120 lbs.	1.4	16	<b>\$625</b>
<b>BSK1209</b>	black	120 lbs.	1.4	16	<b>\$625</b>

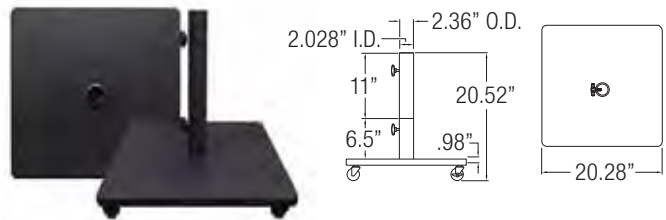

## cast aluminum bases

### monaco (square) w/wheels & handle

Item No.	Finish	Weight	Cube	Pallet	MSRP
<b>BKMSQ1000</b>	bronze	100 lbs.	1.75	24	<b>\$590</b>
<b>BKMSQ1003</b>	white	100 lbs.	1.75	24	<b>\$590</b>
<b>BKMSQ1005T</b>	platinum	100 lbs.	1.75	24	<b>\$590</b>
<b>BKMSQ1009</b>	black	100 lbs.	1.75	24	<b>\$590</b>

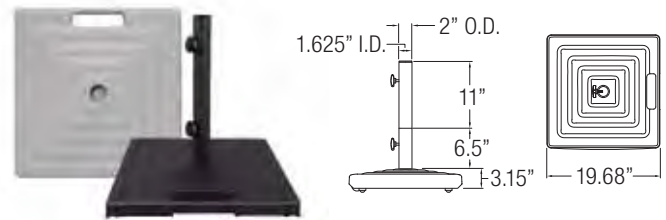

### monaco (round) w/wheels & handle

Item No.	Finish	Weight	Cube	Pallet	MSRP
<b>BKM1000</b>	bronze	100 lbs.	1.75	24	<b>\$590</b>
<b>BKM1003</b>	white	100 lbs.	1.75	24	<b>\$590</b>
<b>BKM1005T</b>	platinum	100 lbs.	1.75	24	<b>\$590</b>
<b>BKM1009</b>	black	100 lbs.	1.75	24	<b>\$590</b>

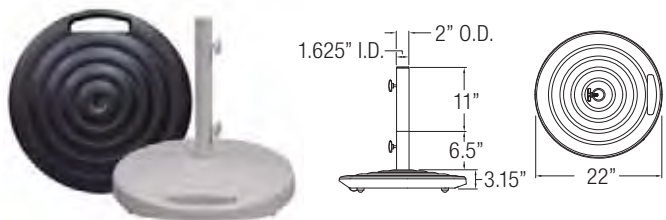

## commercial

Item No.	Finish	Weight	Cube	Pallet	MSRP
<b>BA1500</b>	bronze	150 lbs.	2.8	12	<b>\$710</b>
<b>BA1509</b>	black	150 lbs.	2.8	12	<b>\$710</b>

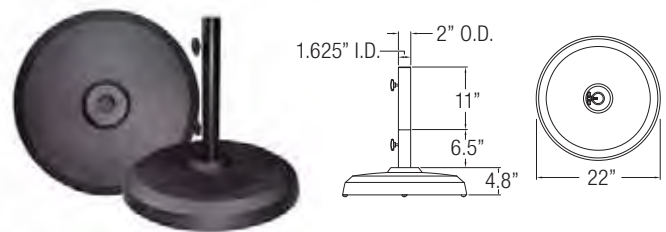

## athens w/wheels NEW

Item No.	Finish	Weight	Cube	Pallet	MSRP
<b>BTT100-AW</b>	arctic white	108 lbs.	3.51	14	<b>\$770</b>
<b>BTT100-SG</b>	shadow graphite	108 lbs.	3.51	14	<b>\$770</b>

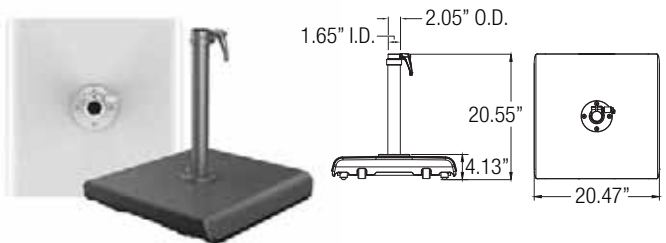

## add-on weight

Optional cast iron weight adds 30 lbs. to our athens and monaco bases.

Item No.	Weight	MSRP
<b>BW30</b>	30 lbs.	<b>\$100</b>



# base weight matrix

Item No.	Size	Canopy Shape	Minimum Base Weight	Mount and Base Options		
				RECOMMENDED	Alternate 1	Alternate 2
<b>LIBRA-20S</b>	6' 6"	SQ	100 lbs.	athens, monaco	(SB) steel base weight	BSK120x, BA150x
<b>LIBRA-25</b>	8' 2"	OCT	100 lbs.	athens, monaco	(SB) steel base weight	BSK120x, BA150x
<b>LIBRA-25S</b>	8' 2"	SQ	100 lbs.	athens, monaco	(SB) steel base weight	BSK120x, BA150x
<b>ASTRAL-TC-35S</b>	11' 5"	SQ	400 lbs.	(2) SBGC200SQ	mount kit	titan base
<b>ASTRAL-TC-40S</b>	13' 1"	SQ	500 lbs.	mount kit	(2) SBGC200SQ + (1) SBGC100SQ	titan base
<b>ASTRAL-TC-50*</b>	16' 4"	OCT	600 lbs.	mount kit	(3) SBGC200SQ	titan base
<b>ASTRAL-TC-50S*</b>	16' 4"	SQ	700 lbs.	mount kit	(3) SBGC200SQ + (1) SBGC100SQ	titan base
<b>SR-27S</b>	8' 9"	SQ	350 lbs.	(2) SBGC200SQ	titan base	mount kit
<b>SR-30</b>	9' 9"	OCT	350 lbs.	(2) SBGC200SQ	titan base	mount kit
<b>SR-30S</b>	9' 9"	SQ	350 lbs.	(2) SBGC200SQ	titan base	mount kit
<b>SR-35</b>	11' 5"	OCT	450 lbs.	(2) SBGC200SQ + (1) SBGC100SQ	titan base	mount kit
<b>POLARIS-30S</b>	9' 9"	SQ	450 lbs.	(2) SBGC200SQ + (1) SBGC100SQ	titan base	mount kit
<b>POLARIS-35S</b>	11' 5"	SQ	550 lbs.	(3) SBGC200SQ	titan base	mount kit
<b>POLARIS-340RT</b>	10' x 13'	RT	550 lbs.	mount kit	(3) SBGC200SQ	titan base
<b>POLARIS-40*</b>	13' 1"	OCT	700 lbs.	mount kit	(3) SBGC200SQ + (1) SBGC100SQ	titan base
<b>POLARIS-40S*</b>	13' 1"	SQ	700 lbs.	mount kit	(3) SBGC200SQ + (1) SBGC100SQ	titan base
<b>OR-27S</b>	8' 9"	SQ	350 lbs.	titan base	(2) SBGC200SQ	mount kit
<b>OR-30</b>	9' 9"	OCT	350 lbs.	titan base	(2) SBGC200SQ	mount kit
<b>OR-30S</b>	9' 9"	SQ	350 lbs.	titan base	(2) SBGC200SQ	mount kit
<b>OR-40</b>	13' 1"	OCT	500 lbs.	mount kit	titan base	(2) SBGC200SQ + (1) SBGC100SQ
<b>GALAXY-35S*</b>	11' 5"	SQ	n/a	mount kit	n/a	n/a
<b>GALAXY-40S*</b>	13' 1"	SQ	n/a	mount kit	n/a	n/a
<b>GALAXY-50*</b>	16' 4"	OCT	n/a	mount kit	n/a	n/a

Note: When stacking steel base weights, the **SB50R** and **SB50SQ** can only be used as the top weight.

\* It is **recommended** that these items be mounted using our in-ground or concrete mount kits (see page 110).

# options

## protective covers

Item	Item No. (Protective Cover)	MSRP
LIBRA-20S	<b>CD951</b>	<b>\$150</b>
LIBRA-25	<b>CD951</b>	<b>\$150</b>
LIBRA-25S	<b>CD950</b>	<b>\$150</b>
ASTRAL-TC-35S	<b>CD9004</b>	<b>\$240</b>
ASTRAL-TC-40S	<b>CD9005</b>	<b>\$240</b>
ASTRAL-TC-50	<b>CD9004</b>	<b>\$240</b>
ASTRAL-TC-50S	<b>CD9005</b>	<b>\$240</b>
SR-27S	<b>CD16A</b>	<b>\$175</b>
SR-30	<b>CD16A</b>	<b>\$175</b>
SR-30S	<b>CD16A</b>	<b>\$175</b>
SR-35	<b>CD16A</b>	<b>\$175</b>

Item	Item No. (Protective Cover)	MSRP
POLARIS-30S	<b>CD36-02</b>	<b>\$210</b>
POLARIS-35S	<b>CD36-02</b>	<b>\$210</b>
POLARIS-340RT	<b>CD36-02</b>	<b>\$210</b>
POLARIS-40	<b>CD36-02</b>	<b>\$210</b>
POLARIS-40S	<b>CD36-01</b>	<b>\$210</b>
OR-27S	<b>CD26A-1</b>	<b>\$175</b>
OR-30	<b>CD26A-3</b>	<b>\$175</b>
OR-30S	<b>CD26A-1</b>	<b>\$175</b>
OR-40	<b>CD26A-1</b>	<b>\$175</b>
GALAXY-35S	<b>CD46-1</b>	<b>\$240</b>
GALAXY-40S	<b>CD46-3</b>	<b>\$240</b>
GALAXY-50	<b>CD46-1</b>	<b>\$240</b>

## optional fabric

Optional Fabric	Price
<b>Glen Raven FIRESIST®</b>	Price Group 1 (+ 25%)



FIRESIST® awning fabric combines state-of-the-art flame retardant performance and UV resistance for the commercial awning, canopy and shade markets.

## specialty canopy

Item	Available Styles	MSRP
<b>Valance</b>	libra	<b>\$240</b>
	astral-tc, sirius, polaris, orion & galaxy	<b>\$385</b>
	astral-tc (5.0m) & galaxy (5.0m)	<b>\$450</b>
<b>Logo Printing</b>	libra, astral-tc & polaris	<b>Call for pricing</b>
<b>Designer Canopy</b>	libra, astral-tc, sirius, polaris, orion & galaxy	<b>Call for pricing</b>



Logo on OR-30S

## replacement canopy

Item No.	Replacement Canopy Grade	
	MSRP Price Group 1	MSRP Price Group 2
C-LIBRA-20S	\$580	\$380
C-LIBRA-25	\$700	\$465
C-LIBRA-25S	\$825	\$565
C-ASTRAL-TC-35S	\$1,925	\$1,270
C-ASTRAL-TC-40S	\$2,190	\$1,450
C-ASTRAL-TC-50	\$2,290	\$1,535
C-ASTRAL-TC-50S	\$2,895	\$1,900
C-SR-27S	\$1,870	\$1,045
C-SR-30	\$1,805	\$1,010
C-SR-30S	\$2,080	\$1,165
C-SR-35	\$2,020	\$1,125

**MSRP Price Group 1**  
Sunbrella®  
Awning Grade

**MSRP Price Group 2**  
O'bravia® Awning Grade  
Sunbrella®/Outdura®/Bliss  
Furniture Grade

Item No.	Replacement Canopy Grade	
	MSRP Price Group 1	MSRP Price Group 2
C-POLARIS-30S	\$2,400	\$1,330
C-POLARIS-35S	\$2,725	\$1,510
C-POLARIS-340RT	\$2,900	\$1,630
C-POLARIS-40	\$2,755	\$1,540
C-POLARIS-40S	\$3,015	\$1,675
C-OR-27S	\$2,185	\$1,220
C-OR-30	\$2,165	\$1,200
C-OR-30S	\$2,265	\$1,270
C-OR-40	\$2,600	\$1,455
C-GALAXY-35S	\$2,985	\$1,785
C-GALAXY-40S	\$3,375	\$2,105
C-GALAXY-50	\$3,560	\$2,225

## replacement frame

Item	Item No. (Replacement Frame)	MSRP
LIBRA-20S	LIBRA-20S	\$770
LIBRA-25	LIBRA-25	\$960
LIBRA-25S	LIBRA-25S	\$1,000
ASTRAL-TC-35S	ASTRAL-TC-35S	\$3,440
ASTRAL-TC-40S	ASTRAL-TC-40S	\$3,920
ASTRAL-TC-50	ASTRAL-TC-50	\$4,105
ASTRAL-TC-50S	ASTRAL-TC-50S	\$4,725
SR-27S	SR-27S	\$2,210
SR-30	SR-30	\$2,120
SR-30S	SR-30S	\$2,450
SR-35	SR-35	\$2,380

Item	Item No. (Replacement Frame)	MSRP
POLARIS-30S	POLARIS-30S	\$2,830
POLARIS-35S	POLARIS-35S	\$3,200
POLARIS-340RT	POLARIS-340RT	\$3,440
POLARIS-40	POLARIS-40	\$3,465
POLARIS-40S	POLARIS-40S	\$3,550
OR-27S	OR-27S	\$2,575
OR-30	OR-30	\$2,545
OR-30S	OR-30S	\$2,675
OR-40	OR-40	\$3,065
GALAXY-35S	GALAXY-35S	\$5,340
GALAXY-40S	GALAXY-40S	\$6,045
GALAXY-50	GALAXY-50	\$6,365

# fabrics

## Price Group 1

Sunbrella®  
awning grade  
100% Solution-Dyed  
Acrylic



**4601** Pacific Blue

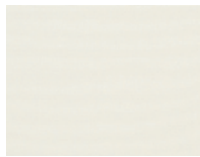

**4604** Natural



**4608** Black



**4642** Oyster



**4644** Charcoal



**4653** Mediterranean  
Blue Tweed



**4666** Logo Red



**4677** Tuscan



**4683** Parchment

## Price Group 2

Sunbrella®/  
Outdura®/Bliss  
furniture grade  
100% Solution-Dyed  
Acrylic



**5401** Pacific Blue



**5403** Jockey Red



**5404** Natural



**5407** Henna

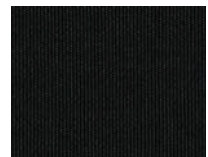

**5408** Black



**5413** Spa



**5416** Aruba



**5417** Tuscan



**5422** Antique Beige



**5425** Cocoa



**5438** Buttercup



**5439** Navy



**5446** Forest Green



**5453** Canvas



**5476** Heather Beige

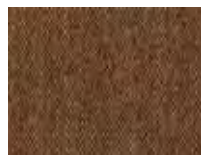

**5488** Teak



**6407** Aquatic



**6433** Neptune



**6439** Ink



**6447** Surf



**6457** Beacon Ash



**6461** Taupe

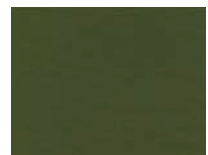

**6463** Reseda



**6660** Harper Ink  
Stripe



**6661** Harper Putty  
Stripe



**6662** Harper Steel  
Stripe



**6663** Harper Crimson  
Stripe



**6664** Churchill Beach  
Stripe



**6666** Paddock Aqua  
Stripe



**6667** Kinzie Smoke  
Stripe

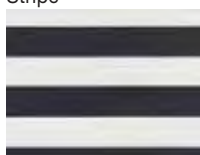

**6668** Kinzie Coal  
Stripe

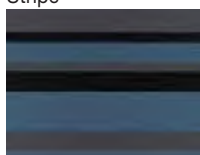

**6669** Horizon Night  
Stripe

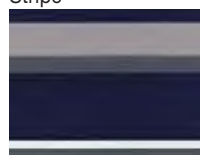

**6670** Reliant Coast  
Stripe

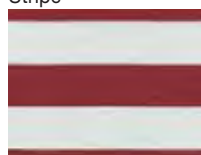

**6703** Kinzie Rose  
Stripe

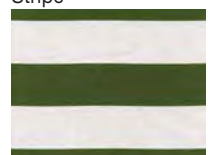

**6711** Kinzie Grass  
Stripe



**6733** Kinzie Royal Stripe



**7816** Tango Glacier

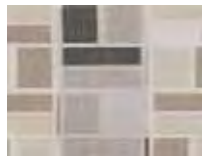

**7822** Mosaic Tile



**7825** Tango Truffle



**7853** Tango Pearl



**8318** Sesame Linen



**14059** Haze



**14067** Mushroom



**40428** Cast Ash



**40433** Cast Silver



**40434** Cast Slate



**40456** Cast Lagoon



**40524-01** Trusted Fog Stripe

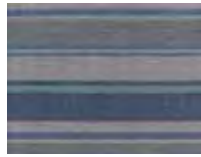

**40524-02** Trusted Coast Stripe



**40584-01** Surround Dusk Stripe



**48080** Spectrum Indigo



**48103S** Cast Ocean



**48135-02** Bliss Sand

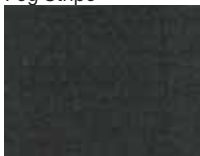

**48135-04** Bliss Onyx



**48135-10** Bliss Pebble



**54011** Ginkgo



**54048** Charcoal



**56079** Milano Char Stripe



**56080** Milano Cobalt Stripe



**56095** Astoria Sunset Stripe



**56096** Astoria Lagoon Stripe



**58039** Gateway Mist Stripe

**NOTE:** Fabric and finishes shown are not to scale. Colors may vary slightly from the actual fabric and finish; please refer to the actual fabric swatch and frame sample to view true color and detail.

**Price Group 2**  
O'bravia®  
awning grade  
100% Solution-Dyed  
Polyester



**5801** Cobalt



**5803** Red



**5804** Eggshell



**5808** Black

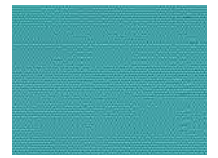

**5816** Aqua



**5822** Khaki



**5825** Mocha



**5827** Chocolate



**5839** Navy



**5850** Kiwi



**5851** Fog

**NOTE:** Striped fabrics must be ordered in pairs, due to cutting requirements. Not available on POLARIS-340RT.

## frame finish collection



**SS**  
Silver Shadow



**UB**  
Urban Black  
Special Order\*

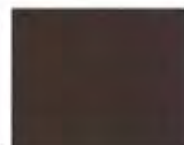

**AB**  
Architectural Bronze  
Special Order\*



**AW**  
Arctic White  
Special Order\*

*Frame finish collection for umbrella styles only.*

*\*Special order frame finishes have a minimum order quantity. Contact your sales representative for more information and specific lead times. Not available on Astral-TC styles.*

# TABLE OF CONTENTS

<b>JCP.101 CENTERPOST ALU</b> 7.5' JCP101-23S 9' JCP101-28	120-121
<b>JCP.201 CENTERPOST ALU</b> 15' JCP201-45	122-123
<b>JCP.301 SIDEPOST ALU</b> 10' JCP301-30S 11.5' JCP301-35	124-125
<b>JCP.401 SIDEPOST ALU</b> 10'x14' JCP401-343RT 13' JCP401-40	126-127
<b>JCP.501 QUAD SIDEPOST ALU</b> 10' JCP501	128-129
<b>FINISHES &amp; FABRICS</b>	130
<b>BASES &amp; MOUNT OPTIONS</b> <b>REPLACEMENT PARTS &amp; OPTIONS</b>	131
<b>ACCESSORIES</b>	132
<b>TERMS &amp; CONDITIONS</b>	134-136
<b>WARRANTY / GUARANTEE</b>	138







jardinico®  
CARACTÈRE



SHOWN: JCP101-28 (CC - Charcoal) in 10022 Natté Grey Chiné

Visit [www.jardinicousa.com](http://www.jardinicousa.com) for more product information.

# JCP.101 CENTERPOST ALU

 7.5 ft Square / 2.3m x 2.3m

 9 ft Hexagon / Ø 2.8m

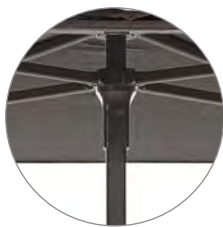

6.42 ft (1.96m)      7.44 ft (2.27m)



6.81 ft (2.08m)      7.63 ft (2.33m)

See page 130 for Finish & Fabric Options.

ITEM NO.	SIZE	CANOPY SHAPE	RIBS	FEATURES	MSRP
JCP101-23S	7.5 ft x 7.5 ft (2.3m x 2.3m)	Square	4	<ul style="list-style-type: none"> <li>Aluminum</li> <li>Magnodraulic Push-Up Lift System</li> <li>Self-Locking Canopy Fasteners</li> <li>Single Wind Vent</li> <li>Protective Cover</li> </ul>	\$1,760
JCP101-28	9 ft (2.8m)	Hexagon	6		\$1,760
ITEM NO.	DESCRIPTION	SIZE	FEATURES	MSRP	
JCB101	Base (with wheels) - 100 lbs.	19.68" x 19.68" x 3.14"	<ul style="list-style-type: none"> <li>Powder Coated, Hot Galvanized Steel Base with 1.88" Locking Wheels</li> </ul>	\$1,130*	

\*Compatible base must be purchased with frame & canopy. Mount kit option not available.



SHOWN: JCP201-45 (CC - Charcoal) in 10059 Natté Dark Taupe

Visit [www.jardincousa.com](http://www.jardincousa.com) for more product information.

# JCP.201 CENTERPOST ALU

 15 ft Octagon / Ø 4.5m

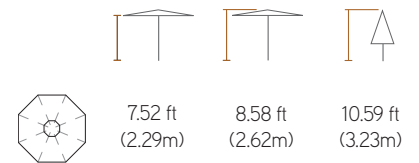

See page 130 for Finish & Fabric Options.

ITEM NO.	SIZE	CANOPY SHAPE	RIBS	FEATURES	MSRP
JCP201-45	15 ft (4.5m)	Octagon	8	<ul style="list-style-type: none"> <li>Aluminum</li> <li>Telescopic Crank Lift System</li> <li>Self-Locking Canopy Fasteners</li> <li>Single Wind Vent</li> <li>Internal Mast Stem Cover</li> <li>Protective Cover</li> </ul>	\$6,665
ITEM NO.	DESCRIPTION	SIZE	FEATURES	MSRP	
JCB201	Base (with wheels) - 350 lbs.	39.37" x 39.37" x 6.29"	<ul style="list-style-type: none"> <li>Powder Coated, Hot Galvanized Steel Base with 3.75" Locking Wheels</li> </ul>	\$3,125*	

\*Compatible base or mount kit must be purchased with frame & canopy. For available mount kit options, see page 131.



SHOWN: JCP301-35 (CC - Charcoal) in 5476 Heather Beige

Visit [www.jardinicousa.com](http://www.jardinicousa.com) for more product information.

# JCP.301 SIDEPOST ALU

☐ 10 ft Square / 3.0m x 3.0m

⬡ 11.5 ft Octagon / Ø 3.5m



Infinite Tilt  
Front to Back, Left to Right



6.89 ft  
(2.10m)

7.64 ft  
(2.33m)

12.64 ft  
(3.85m)

9.73 ft  
(2.97m)

3.89 ft  
(1.19m)



7.06 ft  
(2.15m)

7.58 ft  
(2.31m)

12.98 ft  
(3.96m)

10.04 ft  
(3.06m)

3.48 ft  
(1.06m)

See page 130 for Finish & Fabric Options.

ITEM NO.	SIZE	CANOPY SHAPE	RIBS	FEATURES	MSRP
JCP301-30S	10 ft x 10 ft (3.0m x 3.0m)	Square	8	<ul style="list-style-type: none"> <li>Aluminum</li> <li>360° Rotation</li> <li>Crank Lift System</li> <li>Infinite Tilt (front to back, left to right)</li> <li>Self-Locking Canopy Fasteners</li> <li>Single Wind Vent</li> <li>Internal Mast Stem Cover</li> <li>Protective Cover</li> </ul>	\$3,570
JCP301-35	11.5 ft (3.5m)	Octagon	8		\$3,570
ITEM NO.	DESCRIPTION	SIZE	FEATURES	MSRP	
JCB301	Base (with wheels) - 350 lbs.	39.37" x 39.37" x 6.29"	<ul style="list-style-type: none"> <li>Powder Coated, Hot Galvanized Steel Base with 3.75" Locking Wheels</li> </ul>	\$3,125*	

\*Compatible base or mount kit must be purchased with frame & canopy. For available mount kit options, see page 131.



SHOWN: JCP401-40 (MW - Matte White) in 10022 Natté Grey Chiné

Visit [www.jardinicousa.com](http://www.jardinicousa.com) for more product information.



# JCP.401 SIDEPOST ALU



 10 ft x 14 ft Rectangle / 3.0m x 4.3m

 13 ft Octagon / Ø 4.0m

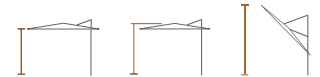

Infinite Tilt  
Front to Back



	7.48 ft (2.28m)	8.49 ft (2.59m)	12.51 ft (3.81m)
	6.52 ft (1.99m)	7.54 ft (2.30m)	14.49 ft (4.42m)

See page 130 for Finish & Fabric Options.

ITEM NO.	SIZE	CANOPY SHAPE	RIBS	FEATURES	MSRP
JCP401-343RT	10 ft x 14 ft (3.0m x 4.3m)	Rectangle	8	<ul style="list-style-type: none"> <li>Aluminum</li> <li>360° Rotation</li> <li>Crank Lift System</li> <li>Infinite Tilt (front to back)</li> <li>Self-Locking Canopy Fasteners</li> <li>Single Wind Vent</li> <li>Internal Mast Stem Cover</li> <li>Protective Cover</li> </ul>	\$7,350
JCP401-40	13 ft (4.0m)	Octagon	8		\$7,350

ITEM NO.	DESCRIPTION	SIZE	FEATURES	MSRP
JCB401	Base (with wheels) - 540 lbs.	39.37" x 39.37" x 7.08"	<ul style="list-style-type: none"> <li>Powder Coated, Hot Galvanized Steel Base with 3.75" Locking Wheels</li> </ul>	\$4,060*

\*Compatible base or mount kit must be purchased with frame & canopy. For available mount kit options, see page 131.



SHOWN: JCP501 (TK - Alu Teak) in 5404 Natural

Visit [www.jardinicousa.com](http://www.jardinicousa.com) for more product information.

# JCP.501 QUAD SIDEPOST ALU

 10 ft Square / 3.0m x 3.0m

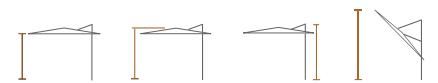

7.50 ft  
(2.29m)

8.25 ft  
(2.51m)

9.75 ft  
(2.97m)

16.33 ft  
(4.98m)



Infinite Tilt Front to Back - Canopies can open and tilt individually

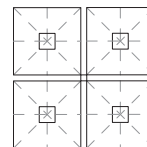

JCP501

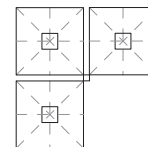

JCP501-P3

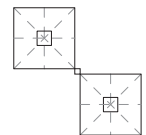

JCP501-P2

See page 130 for Finish & Fabric Options.

ITEM NO.	DESCRIPTION	CANOPY SHAPE	RIBS	FEATURES	MSRP
JCP501	Frame & (4) Canopies	Square 10 ft.	8 per canopy	<ul style="list-style-type: none"> <li>Aluminum</li> <li>Up to 430.5 sq. ft. of Coverage</li> <li>Crank Lift System</li> <li>Infinite Tilt (front to back)</li> <li>Each Canopy Opens and Tilts Individually</li> </ul> <ul style="list-style-type: none"> <li>Self-Locking Canopy Fasteners</li> <li>Single Wind Vent</li> <li>Internal Mast Stem Cover</li> <li>Protective Cover</li> </ul>	\$15,880*
JCP501-P3	Frame & (3) Canopies				\$12,610*
JCP501-P2	Frame & (2) Canopies				\$9,330*

\*Mount kit must be purchased with frame & canopy. For mount kit option, see page 131.

See page 131 for optional (one-piece) Gutter.

# FINISHES & FABRICS

## Finishes



**SS**  
Silver Anodized

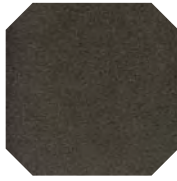

**CC**  
Charcoal



**MW**  
Matte White  
*(Special Order)*



**TK**  
Alu Teak  
Not available on JCP201  
*(Special Order, 5% Upcharge)*

## Fabrics



**10020**  
Natté  
White

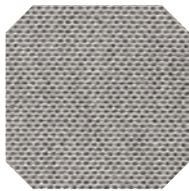

**10022**  
Natté  
Grey Chiné

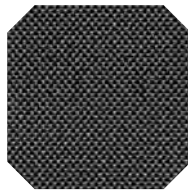

**10059**  
Natté  
Dark Taupe

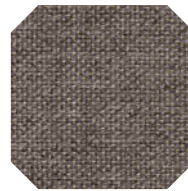

**10065**  
Natté  
Carbon Beige

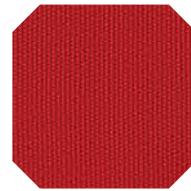

**5403**  
Jockey  
Red



**5404**  
Natural



**5408**  
Black



**5416**  
Aruba

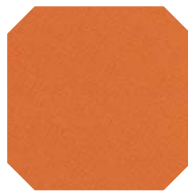

**5417**  
Tuscan



**5439**  
Navy

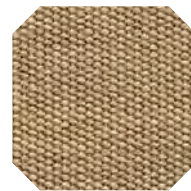

**5476**  
Heather  
Beige

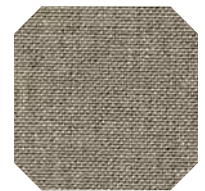

**40428**  
Cast Ash

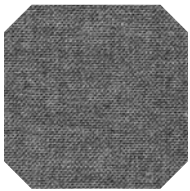

**40434**  
Cast Slate

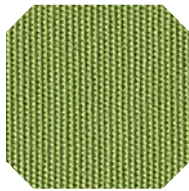

**54011**  
Ginkgo

*Sunbrella® Furniture Grade (non-stock) fabrics available.  
(Special Order, 10% Upcharge)*

*Call for availability.*

NOTE: Fabric and finishes shown are not to scale. Colors may vary slightly from the actual fabric and finish; please refer to the actual fabric swatch and frame sample to view true color and detail.

# BASE & MOUNT OPTIONS

## Compatible Base with Locking Wheels

Base finish matches frame finish except for TK (Alu Teak) which uses the CC (Charcoal) finish.



Locking all weather wheels rotate 360°.

ITEM NO.	DESCRIPTION	SIZE	WEIGHT	FEATURES	MSRP
JCB101	Base (with wheels)	19.68" x 19.68" x 3.14"	100 lbs.	<ul style="list-style-type: none"> <li>• Powder Coated</li> <li>• Hot Galvanized Steel Base</li> <li>• Locking Wheels</li> </ul>	\$1,130*
JCB201		39.37" x 39.37" x 6.29"	350 lbs.		\$3,125*
JCB301		39.37" x 39.37" x 6.29"	350 lbs.		\$3,125*
JCB401		39.37" x 39.37" x 7.08"	540 lbs.		\$4,060*

\*Compatible base must be purchased with frame & canopy. Compatible base not available for JCP.501.

## Compatible Mount Kits

Mount Kit options for concrete and in-ground mounting.

SERIES	MOUNT KIT	ITEM NO.	MSRP
JCP.201 JCP.301	Concrete**	JCB-MKC21	\$385***
	In-Ground	JCB-MKG16	\$265***
JCP.401 JCP.501	Concrete**	JCB-MKC25	\$600***
	In-Ground	JCB-MKG25	\$485***

\*\*Available in CC - Charcoal & 5T - Platinum  
MUST CHOOSE FINISH WHEN ORDERING.

DISCLAIMER: The mount kit should only be professionally installed by a licensed contractor. Jardinico® assumes no liability and expressly disclaims any responsibility for injuries or damages arising from or related to the failure of buyer to have the mount kit installed by a licensed professional contractor. Jardinico makes no warranty except as expressly stated herein, and no warranty except Title to Materials furnished shall be implied with respect to this order.

DISCLAIMER OF WARRANTIES: Except as herein expressly set forth, this product is sold "as is" and "with all faults", and without any implied warranty of merchantability -- which warranty is hereby expressly excluded. This product is sold without any implied warranty of fitness for a particular purpose -- which warranty is hereby expressly excluded. Moreover, there are no warranties which extend beyond the description on the face hereof.

\*\*\*Compatible mount kit must be purchased with frame & canopy.  
Mount kit not available for JCP.101.

# REPLACEMENT PARTS & OPTIONS

## Replacement Canopy

SERIES	FRAME	ITEM NO.	MSRP
JCP.101	JCP101-23S	CJ1-23SQ	\$935
	JCP101-28	CJ1-28H	\$945
JCP.201	JCP201-45	CJ2-45	\$3,490
JCP.301	JCP301-30S	CJ3-30SQ	\$1,540
	JCP301-35	CJ3-35	\$1,540
JCP.401	JCP401-343RT	CJ4-343RT	\$3,185
	JCP401-40	CJ4-40	\$3,085
JCP.501	JCP501	CJ5-30SQ	\$1,540 ea.

## Replacement Protective Covers

SERIES	ITEM NO.	MSRP
JCP.101 (All sizes)	JA-CP902	\$145
JCP.301 (All sizes)	JA-CD35D	\$175
JCP.401 (All sizes)	JA-CD36-02	\$215
JCP.501	JA-CD39	\$400

## Optional (one-piece) Gutter

Custom made and available for JCP.501 styles.

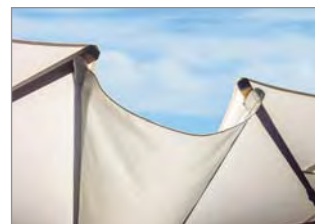

To span big surfaces and canalize rain-water, you can connect several umbrellas with a gutter.

ITEM NO. JCG  
MSRP: \$615 ea.

# ACCESSORIES

ANTIBES WINE TUB



ITEM NO.	HEIGHT	WIDTH	MSRP
JCA-ANT-WTB	9.5"	18.13"	*680

ANTIBES WINE COOLER



ITEM NO.	HEIGHT	WIDTH	MSRP
JCA-ANT-WCO	11.5"	10.63"	*380

ANTIBES LANTERN



ITEM NO.	SIZE	HEIGHT	WIDTH	MSRP
JCA-ANT-SM	Small	15.7"	8.0"	*250
JCA-ANT-MD	Medium	19.7"	8.0"	*400
JCA-ANT-LG	Large	31.5"	12.5"	*690

MOROCCAN LANTERN



ITEM NO.	SIZE	HEIGHT	WIDTH	MSRP
JCA-MOR-SM	Small	15.0"	11.0"	*170
JCA-MOR-MD	Medium	19.7"	11.0"	*200
JCA-MOR-LG	Large	26.8"	11.0"	*250



Lights sold separately



Shade as a style statement.

**jardinico**<sup>®</sup>  
CARACTÈRE



BRANDS

# Terms & Conditions (subject to change without notice)

PAGES 134-136 applies to Treasure Garden, Shademaker and Jardinico.

As a condition of doing business with Treasure Garden, Inc. and its affiliates (hereinafter, "TG") all persons involved in the commercial purchase, sale, or resale of TG products (each, a "Dealer") shall be bound by the following terms and conditions (the "Agreement").

### Distribution:

To qualify as an authorized TG retail Dealer a business must:

- Have a permanent store-front retail business location with reasonable space to display TG products and accessories.
- Maintain an inventory of TG merchandise throughout their outdoor product selling season.
- Reasonably accommodate purchases of anyone showing interest in TG products.
- Be moderately capable of "after the sale" service and support to the end-user and reasonably accommodating of consumer requests for such service and support.
- Retail Dealers should be qualified or trained by their TG sales representative.

TG reserves the right to respond to geographic and individual market and competitive situations by applying different policies to its various Dealers. TG also reserves the right to rescind or modify, in its sole and absolute discretion, any existing or future sales program or policy, or the credit terms (if any) extended to a Dealer. In addition, TG may terminate any authorized Dealer, for any reason or no reason, in its sole and absolute discretion and without notice.

### Credit Terms:

The signature of the TG commercial credit application agreement begins the process of establishing a credit line or billing account with TG. Until a credit application is signed, all orders may require payment in advance; meaning payment must be paid prior to our manufacturing of the order. Minimum annual orders of \$5,000 are required during TG's fiscal year (i.e., Oct. 1 - Sept. 30) for any new or re-established account. TG generally offers payment terms of Net 30 days (on approved credit) to an authorized retail Dealer that has signed the credit application. Other credit terms may be available and will be indicated on the Sales order acknowledgement and Invoice. Payment terms for Freight Charges and/or duties are Net 7 days. All orders are subject to credit approval and acceptance by our home office in Baldwin Park, California and TG may terminate the extension of credit, for any reason or no reason, in its sole and absolute discretion. Any disputes between TG and a Dealer may be brought in the Courts located in California regardless of where the Dealer is located. Time is of the essence concerning all payments, and payments must be sent so as to be received by the due date. No deductions or debit memos are accepted. A service charge of one and one-half percent (1.5%) per month or such maximum lesser rate as may be permitted by law will be assessed to all past due invoices. Invoices are considered past due if the payment is not received by the due date.

Credit files are routinely reviewed, and a current financial statement or information may be requested by TG and must be provided within 14 calendar days. TG may also request assurances of a Dealer's ability to pay and may, upon the making of such request, stop production and suspend shipments.

### Prices:

Prices listed in the catalog are suggested retail prices. A Dealer's cost is based on the designated Dealer classification. Ask your Sales Representative for details regarding TG's 2022 programs and pricing structure.

### Taxes and Surcharges:

The Manufacturer's Suggested Retail Price ("MSRP") does not include any state tax, local tax or surcharges. California sales tax may apply to shipments made within California, picked up at our California facility or drop shipped within the state of California unless we have a CA resale certification on file. For shipments out of CA the appropriate sales taxes will be added to acknowledgements or invoices unless we are provided with a valid State sales tax exemption certificate. Sales taxes will be added based on the address where the product is being shipped to. We collect sales tax in our nexus states, as of January 2020 our nexus states are AR, AZ, CA, CO, CT, FL, GA, IA, ID, IL, IN, KY, LA, MA, MD, ME, MI, MN, MO, NC, NE, NJ, NM, NV, NY, OH, OK, PA, RI, SC, TN, TX, UT, VA, WA & WI. Please note that CA, MA & MI will not accept another states resale certification or resale number for tax exempt purposes.

### Order Acceptance:

We accept orders from an authorized retail Dealer or contract accounts only. Ask your sales representative for details on becoming an authorized retail Dealer or contract account. If you place an order with Treasure Garden and you or your designee accepts delivery of any goods in relation to the order (whether or not you believe the delivery conforms with the order) you will be bound by the terms and conditions of our 2022 catalog.

If you do not accept all of the Catalog Terms you must notify us in writing within 10 days of receiving your acknowledgement or the goods, whichever occurs sooner, to cancel or return the order at your expense. If you fail to do so, you will be bound by the Catalog Terms. In the event of a conflict between the terms on any purchase order, invoice, acknowledgement, or other document and the Catalog Terms, the

Catalog Terms will prevail.

### Opening orders under \$5,000 (or clients without open credit terms):

Orders must be paid in advance via business check, cashiers check or wire transfer before the order is manufactured (we do not process C.O.D. orders or hold credit card information on file). Once your order is sent in, please allow at least 3-5 days for us to process and price your order. We will email an order quote with your prices, estimated shipping charges and prepayment instructions. Once your payment is cleared from the bank, a new acknowledgement will be issued with your estimated ship date. Clearing of checks may take anywhere from 2-5 business days for any checks issued from domestic banking institutions.

International checks are not accepted. It is best to pay orders via Wire Transfer on all international orders to avoid delays in processing.

After the order is released to production, please allow at least 3 weeks for your order to be processed and shipped.

### Opening orders over \$5,000:

Dealers must send in order with a complete TG Credit Application Agreement. However, all Dealers will be bound by this Agreement regardless of whether they sign the TG Credit Application Agreement.

Allow a few days for credit processing and approval; allow at least three weeks delivery time for items purchased on credit. If you do not wish to establish open terms, please review the preceding section. These are estimated times only. A more accurate shipping date will be provided on your order acknowledgement.

### Order Policy:

To ensure that your order is processed without delay we require:

- A written purchase order (no phone orders) from an authorized Dealer including the business name, account number, phone number and purchase order number.
- Ship date and specific shipping instructions. If you request freight collect or 3rd party billing, please provide the account number.
- Our item/style number, fabric number, type and color.
- Quantity of each style.
- Customer's name on all Special Orders.
- Order type:

SP = Special Promotions                      EEB = Early Early Buy  
 TGEX = TG Express Order                    EB = Early Buy  
 CQS = Cantilever Quick-Ship

**NOTE:** Dealers who place a single purchase order without specifying a specific program, the order will automatically be shipped out at the longer lead time based on the items ordered. Dealers who want separate shipments with different lead times (i.e. - TGEx and Custom), please write separate purchase orders per program and make sure correct items are offered in those programs. Dealers who place a single purchase order specifying multiple or incorrect programs based on items ordered, the order will automatically be split-shipped separately according to their respective programs.

A 50% deposit may be required for orders that contain custom, exclusive items or large quantities. The deposit must be made before the order is scheduled into our system.

Please note that any discrepancies in your purchase order can cause significant delays. You must review the acknowledgment for accuracy and advise TG immediately of any discrepancies or changes. Lead time starts once order is finalized.

### Changes/Cancellations:

No cancellations, changes, additions or holds will be accepted for an order for which materials have been ordered or produced. Cancellations and/or changes of product or shipping dates on EARLY BUY orders (as defined below) must be received at our office in writing within 15 days of the acknowledgement date. Cancellations and/or changes of product or shipping dates on custom orders must be received in writing within 3 business days of the acknowledgement date. Order revisions will no longer be accepted for Quick-Ship programs if the order has already been processed in the system or after 24 hours, whichever occurs first. No cancellations or revisions will be accepted after 72 hours for non-stock fabric orders. NO EXCEPTIONS. Orders that do not follow these guidelines will be charged a 25% re-stocking or handling fee. We cannot guarantee that purchase orders added to an existing order will be shipped together. If items are added to an order or an item on an order is changed, the entire order may be rescheduled as of the date of the change. This may result in a later ship date than the original order. In the event an order is refused and returned to us, a 25% restocking/handling fee may be assessed in addition to the inbound and outbound freight charges. The 25% restock fee also applies to pro forma orders that are cancelled due to nonpayment.

### Container Orders:

Due to the special pricing on container orders, all containers must be prepaid via wire transfer or paid by letter of credit. If you have not placed a prior container order



or if there were previous payment delays or if there are non-stock/custom items on the order, we may require a 50% deposit before we start manufacturing the order. The remaining balance will be due two weeks before the order is shipped. The purchase of a container may also involve bank charges and other charges unrelated to the price of the product including but not limited to duties, storage, shipping and transportation charges, third party inspection charges whether inspected at point of origin, point of entry or point of delivery. Once your purchase order is sent in, we start reviewing and scheduling your order into our production schedule. It is important that you inform the Baldwin Park office of any order changes within 10 business days from when your order is sent in. After reviewing your purchase order, we will mail or fax an order acknowledgement with your payment instructions.

We must be informed of any discrepancies or revisions to CONTAINER ORDERS in writing within 10 business days of sales order acknowledgment date. No cancellations are allowed. When placing orders, please be mindful of Chinese New Year. Generally, our manufacturing schedule is tight around that time.

#### **Back Order/Partial Shipments:**

Due to the considerable number of items we offer, we may not initially be able to ship or deliver your entire order. In such event the balance and/or entire order thereof will be back-ordered and shipped and delivered at a subsequent time or times. Standard shipping charges will apply to partial or back order shipments.

#### **Lead Times:**

**TG CUSTOM:** Our goal is to ship custom in stock fabric orders within 6-8 weeks of the acknowledgement of the order, 8-10 weeks for non stock fabrics.

**EARLY BUY:** We will make every effort to ship orders received during the EARLY BUY period within 30 business days of the estimated ship date. All scheduled shipments will be at the factory's convenience.

**TGEx:** Our goal is to ship TG EXPRESS orders within 5 business days of the acknowledgment of the order.

**CQS:** Our goal is to ship CANTILEVER QUICK-SHIP orders within 7 business days of the acknowledgment of the order.

Notwithstanding anything to the contrary herein, TG does not guarantee that any shipments of any type of product or order will be delivered at or before a date certain. All large quantities may result in partial shipments. This is a goal – not a guarantee – and may be slightly affected by availability of fabrics & consumer demands.

ALL SHIPMENTS - TG shall, in the event of no routing instructions from the buyer; select a carrier, which it feels, in its sole discretion, can adequately handle each shipment.

#### **Order Scheduling:**

Deliveries are subject to fire, storm, flood, war, rebellion, riot, strike or labor trouble, interruptions to transportation, perils of navigation, damage to factory, equipment of facilities, governmental mandates, including the exercise of acts of God, failure of our sources of supply in whole or in part, and other cause beyond our control. We shall not be liable for any damages or failure to deliver or delay in delivery due to any such causes. If possible we will attempt to ship merchandise the week of the requested ship dates.

However, in order to maintain an orderly schedule, we reserve the right to schedule the merchandise shipment to the nearest available production schedule and to ship accordingly.

Our regular business days are Monday through Friday.

#### **Early Buy Orders:**

The deadline for the 2022 Season Early Buy Program is October 1, 2021. These dates are subject to change depending on our production schedule. Due to special payment terms of the Early Buy order, we are unable to restrict or limit the shipping dates; you must be prepared to accept shipment of the Early Buy order at TG's sole convenience. There is a minimum of \$5,000 for Early Buy orders. A 50% deposit may be requested for customers placing their 1st Early Buy order if there were issues with previous orders, the order exceeds the approved credit line or there is custom product that is being ordered. The deposit must be made before the order is scheduled into our system. Ask your Sales Representative for details on our EARLY BUY program.

#### **Freight Charges:**

The shipping charges on your invoice may differ from those on your acknowledgement. This is largely due to instability in today's fuel economy. Please understand that these charges are assessed by the carrier, not TG. These charges can sometimes include fuel surcharges, lift gate, extra delivery charges, as well as standard pallet fees and box pallet fees which may not have been indicated on the preliminary freight quotes. The pallet fees may increase depending on the cost of these items.

If the freight charges are prepaid & added to your invoice, the shipping charges may include any applicable pallet charges. To ensure the most economic freight for our customers, we are constantly reviewing freight rates. If we ship your orders freight collect or 3rd party billing we will bill your company for any applicable pallet charges.

#### **Freight Claims:**

All merchandise is delivered to the carrier in factory new condition. Our FOB shipping points are Baldwin Park, CA or Ningbo, China.

The FOB location depends on your order type and product availability. The carrier accepts responsibility for the safe delivery upon acceptance of the shipment.

TG should be notified immediately regarding any claims. Claims for loss or damage sustained in transit must be filed by the Dealer, as follows:

##### Visible Damage:

It is the Dealer's responsibility to check the merchandise and file a claim with the carrier if the shipment was made using the dealer's carrier and account. Request a claim form from the delivering carrier and file your claim immediately. If the shipment was made using TG's carrier and account, it is the Dealer's responsibility to check the merchandise and notify TG immediately of the situation so that a claim can be filed. In either situation, make a notation on the Bill of Lading as to the nature and extent of the damage and obtain a signature of the carrier's agent. (Failure to adequately describe this information may result in the carrier refusing to honor the claim and TG will not, under any circumstances, be liable for damage sustained in transit).

##### Concealed Damage:

If damage is discovered when unpacking the merchandise, immediately mark the damaged area and submit a written request for the carrier to inspect. Attach a copy of the concealed damage information. Do not remove the merchandise from the original carton until the carrier inspection is complete. If the merchandise was shipped using TG's carrier and account, it is the Dealer's responsibility to notify TG immediately of the situation so that a claim can be filed. Concealed damage needs to be reported and claim filed within 5 days for all carriers.

##### Shortage:

It is the Dealer's responsibility to inspect all merchandise and to file claims with the carrier in the event of product shortage. Make a notation on the Bill of Lading as to the number of cartons short. TG must also be notified immediately of any shortages. File the claim with the delivery carrier immediately. No claim for shortages, damaged items or errors will be honored unless it is made in writing on the Bill of Lading immediately upon receipt of the shipment. Notwithstanding anything to the contrary in this Agreement, failure to make a claim on the Bill of Lading will constitute a waiver of any rights to a refund or credit.

##### Return Goods:

No returns will be accepted without a written Return Authorization (RA#) from the factory. A request for return must be done within 30 days of delivery and all RA's are valid for 60 days. It is the Dealer's responsibility to follow routing instructions. Please fax in a request for an RA#. Your request must include the following information:

- Company name, contact name, number & store hours;
- The TG invoice and/or acknowledgement;
- The item no., number of units to be returned and carton total;
- The reason for the return; and
- Which carrier will be returning the goods and the date of the shipment.

Any item that is returned for credit that is not under TG's warranty policy is subject to a 25% restocking fee (and must be properly packaged) plus inbound and outbound freight charges, if applicable. Any item that is returned for repair or replacement that is not under TG's warranty policy is subject to the applicable repair charges listed in the "Other Fees" section, below. FOR FULL CREDIT CONSIDERATION, RETURNED MERCHANDISE MUST BE BOXED & IN NEW CONDITION. TG will only organize the return of product for warranty determination from the original point of shipment within the US and Canada. Per the Treasure Garden Limited Warranty, Treasure Garden restricts warranty service for TG products to the country where Treasure Garden or its authorized TG retail Dealers originally sold the product.

#### **Errors:**

There may be errors in the prices, descriptions or images of certain merchandise in our catalog or sales material. We reserve the right to restrict orders of those items.

#### **Other Fees:**

These fees apply to both contract accounts and retail Dealers.

- Non-warranty repairs are subject to a labor charge of \$35 per hour plus applicable parts, inbound and outbound freight charges. Please allow at least 5 business days for processing.
- A \$15 handling fee will be added to any purchase under \$50. To avoid this fee, please accumulate your product needs and place orders together. DOES NOT APPLY TO PARTS, FABRIC BY THE YARD OR DISPLAY STANDS.
- A \$15 drop shipment fee will be added to drop shipment orders. We can drop ship orders to US addresses only. The appropriate sales and use tax will be added to the orders unless we have a resale certification for the state that the items are being shipped to. Depending on the item, additional delivery charges may apply. TG reserves the right to rescind or modify, at its sole discretion, drop shipments or the drop shipment of specific items.
- A \$25 service charge will be assessed on any returned check.
- Residential delivery fees, lift-gate fees, limited access and "call before delivery" fees vary depending on the carrier.
- A Materials Handling Fee may be assessed for palletized orders shipping LTL freight collect or when special labels are required to print for each order.

#### **Shipping:**

Most TG products can be shipped using parcel companies (UPS, FedEx or other). Some of our larger or heavier products however, must be shipped with a trucking company. Such products are identified with the "Truck Only". TG can only ship to

addresses in the US and Canada. If shipping to Canada, you must have your own broker to clear items through customs and this information must be provided with the purchase order.

#### **Treasure Garden Storage Policy:**

We reserve the right to assess storage fees if you are not able to receive the product when Treasure Garden is ready to ship, your carrier does not pick up within 3 days of notification that the shipment is ready or after a 3-day grace period\*. The grace period starts the day after the original Estimated Ship Date on your Order Acknowledgement (or the date the product is ready to ship). When the grace period expires, the following storage policy and pricing will be applied:

- Un-palletized orders are \$50 per day\*
- Palletized orders are \$50 per day\*; plus an additional \$20 per pallet

\*All time frames referenced in policy are business days

† Customer is responsible for all shipping charges if they are unable to receive shipment when carrier is ready to deliver. This includes but is not limited to, storage and re-delivery fees.

†† Storage is not available for Cash In Advance customers.

#### **Payments:**

Payment will be accepted in US Dollars only. If a deposit or pre-payment is paid by a standard business check drawn on a domestic banking institution, please allow 2-5 business days from TG's deposit date for your funds to clear. If paid by a standard business check drawn on an International banking institution, please allow 4-6 weeks from TG's deposit date for your funds to clear. If your deposit is prepaid via wire transfer, please allow 1 business day for your funds to clear. Invoice payments should be sent to be received on or before the due date at our corporate office in Baldwin Park, CA at the address in the "Notices" section, below. Payments made in a different manner may be delayed.

#### **Pricing:**

"MSRP" means the Manufacturer's Suggested Retail Price as set forth in this Catalog. "MAP" means the Minimum Advertised Price as set forth in this paragraph. Dealers must adhere to MAP requirements when advertising via any traditional media, in all online advertising, online comparison price shopping, and landing pages. Dealers cannot advertise TG products below a published Net MAP price list effective the start of each fiscal year. TG reserves the right to adjust MAP pricing based on MSRP and/or MSRP pricing, changes due to tariff implementation and/or other unforeseen market conditions, as needed during the fiscal year. This net pricing is inclusive of, but not limited to, discounts such as coupons, promo codes, email "sign up" discounts and sales tax. In addition, no advertisements may state or otherwise suggest that the TG MSRP is higher than the actual MSRP as set forth in this catalog. It is also incumbent on all dealers to update their pricing January 15, 2022 for 2022 season to reflect any changes to MSRP and MAP that might occur. MAP Policy may vary for international dealers, please see your local sales representatives for details.

#### **Minimum Advertised Price Requirements:**

As in any Minimum Advertised Price ("MAP") program, the intent is to uphold the integrity of the Treasure Garden line of products and protect the investments made by Treasure Garden and its Dealers and retail partners. Violating MAP requirements only serves to devalue the brand in the eyes of the consumer. These MAP requirements apply to any Dealers advertising TG products via traditional media including, but not limited to, newspapers, mailers, inserts, circulars, magazines, catalogs, television and radio. In addition, the MAP requirements apply to any Dealers selling or advertising TG products online and/or having a checkout/cart system.

#### **MAP Policy Violation Enforcement:**

TG reserves the right to determine, in its sole and unfettered discretion, whether a violation of the MAP requirements has occurred. If TG determines that a Dealer has violated the MAP requirements, TG may, in its sole and unfettered discretion, terminate its relationship with the Dealer without notice or an opportunity to cure. The Dealer agrees that money damages or other legal remedies would not, standing alone, be a sufficient or adequate remedy for any breach or violation of the MAP requirements. As such, in addition to all other remedies available to TG, TG shall be entitled to an injunction restraining such breach or violation and to other equitable relief, including specific performance, without a bond or other security being required.

#### **Product Advertising:**

All TG products advertised may include the Treasure Garden name in the product description. Product advertising may include proprietary names (e.g., O'bravia®, Solefin®, etc.) and the Treasure Garden logo in product descriptions. Product names cannot be changed without prior approval (e.g. EVO, Polaris, etc.). Dealers may use their own images of TG products that they have taken themselves OR use images offered in TeamTG. Treasure Garden logos and logos of proprietary products will be provided on TeamTG. Lifestyle images provided by Treasure Garden should not be altered without prior approval. The Dealer's permission to use the Treasure Garden brand, tradenames, logos, images, and any intellectual property is subject to the Dealer's strict compliance with this Agreement including, but not limited to, the MAP requirements.

#### **Bulk Sale Restrictions:**

If a Dealer decides to resell product to a third party said Dealer is responsible for any warranty or service issues, as well as is still bound to this agreement. The third party is not under agreement with TG, it is the Dealer that is doing business with TG.

#### **Duty to Notify TG of Complaints:**

Dealers shall make a careful and thorough inspection of all goods received. Subject to and without limitation of the requirements of the "Freight Claims" section above, Dealers must notify TG in writing of any complaints or issues, whether existing or reasonably foreseeable, relating to TG's performance including, but not limited to, discrepancies in quantity or description of items delivered, defects or potential defects in items delivered, or any other issue whatsoever relating to TG's performance (except issues relating to billing disputes, which are dealt with in the next section.) Notice shall be provided to TG within 30 days of:  
(i) the Dealer's receipt of any defective or non-conforming goods, or (ii) the time any other issue complained of came, or should, with reasonable care, have come to Dealer's attention – whichever is earlier. Unless timely notification is received by TG in accordance with the terms hereof, which notice shall identify with particularity all complaints or issues asserted by the Dealer, the Dealer irrevocably waives any and all complaints relating to any defective or non-conforming product or any other issue whatsoever relating to TG's performance and the Dealer shall have no recourse against TG. The Dealer shall be solely responsible for retaining proof that the written notice required by this section was received by TG.

#### **Payment Obligations:**

Dealers agree to examine immediately upon receipt each of TG's statements of account, invoices, or other billing statements (collectively, "Bills"), and to notify TG in writing of any disputed Bills within 10 days of receipt. Such disputes may include, but are not limited to, disputes relating to charges for items that were billed but not received; charges for product that was received but not ordered; or charges for items that were returned, refused, credited, or have a freight claim pending. Dealers will not withhold payment when disputes arise. Only the disputed portion of a timely disputed past-due balance may be withheld. Unless timely notification is provided to TG in accordance with the terms hereof, which notice shall identify with particularity any and all objections to any of TG's Bills, the Dealer irrevocably waives any and all objections to TG's Bills. In addition, the Dealer agrees that its obligation to pay TG is separate and independent from any obligations TG may have to the Dealer. In the event the Dealer fails to pay TG in accordance with the terms hereof, the Dealer irrevocably waives the right to assert any and all claims, offsets, or any other defenses whatsoever to TG's right to payment. The Dealer further agrees that any payments to TG may be applied to any invoices or other indebtedness owed to TG, in TG's sole and absolute discretion. The Dealer shall be solely responsible for retaining proof that the written notice required by this section was received by TG.

Statements are sent on the 1st business day of each month.

#### **Attorneys' Fees:**

The Dealer agrees that it shall be liable for all of TG's attorneys' fees (including local counsel fees), experts' fees, accountants' fees, court fees, collection costs, collection agency fees (if applicable), and any other expenses, whether or not incurred in connection with litigation or arbitration, arising from the breach of any term of this agreement by the Dealer, and/or in connection with the enforcement of any judgment or award rendered in favor of TG.

#### **Governing Law:**

You agree that all matters relating to your purchase and use of TG products, including all disputes, will be governed by the laws of the United States and by the laws of the State of California without regard to its conflicts of law provisions. You agree to the personal jurisdiction by and venue in the state and federal courts in Los Angeles County, California, and waive any objection to such jurisdiction or venue.

#### **No Waiver:**

None of TG's rights hereunder will be deemed to be waived or modified in any way based upon the manner in which this Agreement is performed or TG's failure to enforce its rights hereunder or insist on strict and timely performance of the Dealer's obligations. Without limitation to the foregoing, acceptance of payment outside of the stated credit terms shall not operate as a waiver of the stated credit terms.

#### **Limitation on Liability:**

In no event will TG be liable to the Dealer for any lost profits, lost savings, or any consequential, incidental or special damages arising out of or in connection with the parties' relationship, even if TG has been put on notice of the possibility of such damages. Without limitation to the foregoing, under no circumstances will TG be liable to the Dealer for punitive damages.

#### **Disclaimer:**

Please note that TG, reserves the right to alter or modify product styles and to discontinue frames and fabrics without notice. For more information about TG products, please contact us at: (626) 814-0168 or email: [info@treasuregarden.com](mailto:info@treasuregarden.com)

#### **Notices:**

All written notices required hereunder shall be ineffective unless sent to the following addresses by Federal Express and email:

**info@treasuregarden.com** – and – **Treasure Garden, Inc.**  
13401 Brooks Drive  
Baldwin Park, CA 91706

#### **Headings:**

Section headings are inserted for ease of reference only and shall have no effect on the interpretation of this agreement.

## Warranty/Guarantee

Treasure Garden items are designed for residential use and are not warranted for commercial applications (unless specified for Commercial use).

### LIMITED WARRANTY (Frames and Accessories)



#### One (1) year

Starlux AKZ Plus Rechargeable Battery Pack  
AG Cantilever styles  
Quad Pulley Lift – UM8091 style  
Glide Tilt styles  
Push Button Tilt styles  
Umbrella Bases & Accessories  
Umbrella Lights  
Outdoor Rug  
Protective Furniture Covers



#### Two (2) years

Starlux AKZ Plus Cantilever style  
AKZ Plus Cantilever styles  
Vienna Alu Teak – UV89115A style  
Shanghai Collar Tilt – USA459 style  
Starlux Collar Tilt – UM800\_LX style  
Collar Tilt – UM80\_\_ series  
Auto Tilt – UM81\_\_ series  
Auto Tilt – UM8810RT style  
Crank Lift – UM8811RT style



#### Three (3) years

Commercial – UCP40\_\_ series

#### Limited Warranty Includes:

Powder coated finish, frame, ribs, finial, tilt, cord, crank handle, housing, canopy and rib pocket seams. If a defect in the original material or workmanship appears during the warranty period on any Treasure Garden product; Treasure Garden, at its option, will repair or replace the product without charge.

#### Authorized Retailer:

Requests for returns must be FAXED in to **(888) 821-8868**  
Attn.: Customer Service or contact a Customer Service Rep.

#### Limited Warranty Fabric (Furniture Grade):

The following fabric lines have a limited warranty against fading for:  
5 years - Sunbrella®/Outdura®/Bliss  
4 years - O'bravia®

The Limited Warranty only applies to TG product purchased directly from Treasure Garden, Inc. and its affiliates, or an authorized TG retail Dealer, as defined in our Terms and Conditions; the Limited Warranty is not transferable. Should the Purchaser or Owner sell the TG product to another party, the warranty will not transfer to the new owner.

#### What Is NOT Covered:

Failure caused by unreasonable or abusive use, or failure caused by neglect of reasonable and necessary care, and any modification to product are not covered by this warranty.

Additionally, acts of nature (including but not limited to wind, hurricanes, tornadoes, and storms) are not covered by this warranty. This warranty covers return freight of any warranted product only for the first year. This warranty gives you specific legal rights and you may have other rights which vary from state to state.

Closeout and promotional items sold by the dealer as is are not covered by this warranty.

#### Wind Damage:

Treasure Garden highly recommends that no umbrella, regardless of size or weight, ever be left unattended in the open position. In windy conditions, it is further recommended that umbrellas be closed, removed from their base, and stored or laid horizontally. This will reduce the risk of personal injury, damage to your umbrella, furniture, and other belongings or property. To ensure stability of your umbrella, please observe proper placement, and use sufficient base weight. This catalog contains minimum recommendations for necessary weight for each style. Keep umbrella properly secured to umbrella base at all times. Thoroughly read and follow all provided instruction manuals.

#### WIND DAMAGE IS NOT COVERED UNDER OUR LIMITED WARRANTY.

#### Irregularities in Production Process:

The possibility of "Irregularities" in the product surface may occur during the production process. However, these irregularities do not reduce the quality of the product. Treasure Garden monitors every stage of production to ensure a clean and consistent appearance on every part.

#### Rust:

Rust is a natural part of the aging process of all Steel or Iron based materials and is therefore NOT considered a defect. Treasure Garden Cast Iron & Steel plate bases are designed to require minimum maintenance. Bases should be kept clean.

Do not let dirt build up on the bases. Cleaning with mild soap and water, and seasonal touch-up of any scratches, chips or occasional rust seepage from crevices or hidden, un-finishable surfaces inherent in some designs is all that is required. Touch Up paint in matching frame colors are available through your retail dealer. Never leave bases standing in water. To keep your bases looking their best, you may wish to store them when not in use for an extended period of time.

#### Seaside and Indoor Pool Usage:

CAUTION: Seaside and indoor pool use, salt & chlorides can accumulate on the powder coat finish, leading to finish failure. Failure or neglect to make needed cleanings may cause paint to blister, and such failure will void limited warranty.

#### International Returns:

If an item is found to be under warranty Treasure Garden shall only be responsible for ground shipping charges to the location of the product within the continental United States. Any duties, express, international or special shipping charges are at the expense of the retail dealer or consumer.

#### IMPORTANT RESTRICTION FOR TG PRODUCTS WARRANTY SERVICE:

Treasure Garden restricts warranty service for TG products to the country where Treasure Garden or its authorized TG retail Dealers originally sold the product.

#### NO RETURNS ON CUSTOM, VALANCE OR DESIGNER CANOPY STYLE UMBRELLAS.

#### THE SELLER DISCLAIMS ANY IMPLIED WARRANTY OF MERCHANTABILITY.

Shademaker and Jardinico<sup>®</sup> manufacture all its shade styles from the finest aluminum alloys to ensure the strength, durability, and integrity of each and every style. We pride ourselves as a totally vertical operation. This means that we manufacture and produce over 90% of the components used in our products from the raw state. We can monitor every stage of the manufacturing process and maintain a consistent level of quality.

Our goal is that each and every Shademaker and Jardinico style will exceed your expectations.

Our **Limited Warranty** is outlined below. NOTE: Wind damage is not covered under any manufacturer's warranty.

**5 Year Limited Warranty** includes the mast, boom, head fitting, elbow, center pole/sidepost, arms, ribs, top and bottom hub and stainless steel hardware only. If there is damage under the warranty, Shademaker/Jardinico will replace and/or repair any item listed in this category at its discretion. Labor charges are not covered under this limited warranty.

**5 Year Limited Warranty** applies to Glen Raven FIRESIST<sup>®</sup> and Sunbrella<sup>®</sup> furniture grade, Outdura<sup>®</sup> furniture grade and O'bravia<sup>®</sup> awning grade fabrics. Visit [www.sunbrella.com](http://www.sunbrella.com), [www.outdura.sattler.com](http://www.outdura.sattler.com) and [www.blissfabrics.es](http://www.blissfabrics.es) for more details. Labor charges are not covered under this limited warranty.

**10 Year Limited Warranty** applies to Sunbrella awning and marine grade fabrics collection. Visit [www.sunbrella.com](http://www.sunbrella.com) for more details. Labor charges are not covered under this limited warranty. NOTE: Sunbrella awning/marine fabric is treated with a finish which gives the fabric its water repellency and a firmer hand which helps in the sewing and fabrication of the products. Mark-off/Crazing may appear as white scuff marks or thin white lines on the fabric which will normally diminish or go away with normal weathering and will not affect the overall performance of the product.

**1 Year Limited Warranty** covers the wheels, powder coat finish, rust and corrosion on all bases. If the powder coat finish flakes, bubbles, peels or loses color; Shademaker/Jardinico will re-finish or replace the defective base at its discretion. Normal wear and tear is not covered under this limited warranty. Labor charges are not covered under this limited warranty.

**1 Year Limited Warranty** covers protective covers and Jardinico Accessories.

#### **What Is NOT Covered:**

Failure caused by unreasonable or abusive use, or failure caused by neglect of reasonable and necessary care, and any modification to product are not covered by this warranty.

Additionally, acts of nature (including but not limited to wind, hurricanes, tornadoes, and storms) are not covered by this warranty. This warranty covers return freight of any warranted product only for the first year. This warranty gives you specific legal rights and you may have other rights which vary from state to state.

Any Shademaker Galaxy styles that do not have spacer buttons installed are not covered by this warranty. Closeout and promotional items sold by the dealer as is are not covered by this warranty.

#### **Wind Damage:**

Shademaker and Jardinico highly recommends that no umbrella, regardless of size or weight, ever be left unattended in the open position. In windy conditions, it is further recommended that umbrellas be closed, removed from their base, and stored or laid horizontally. This will reduce the risk of personal injury, damage to your umbrella, furniture, and other belongings or property. To ensure stability of your umbrella, please observe proper placement, and use sufficient base weight. This catalog contains minimum recommendations for necessary weight for each style. Keep umbrella properly secured to umbrella base at all times. Thoroughly read and follow all provided instruction manuals.

**WIND DAMAGE IS NOT COVERED UNDER OUR LIMITED WARRANTY.**

#### **Seaside and Indoor Pool Usage:**

CAUTION: Seaside and indoor pool use, salt & chlorides can accumulate on the powder coat finish, leading to finish failure. Failure or neglect to make needed cleanings may cause paint to blister, and such failure will void limited warranty.

#### **Irregularities in Production Process:**

The possibility of "Irregularities" in the product surface may occur during the production process. However, these irregularities do not reduce the quality of the product. Shademaker and Jardinico monitors every stage of production to ensure a clean and consistent appearance on every part.

#### **Rust:**

Rust is a natural part of the aging process of all steel based materials and is therefore NOT considered a defect. Steel plate bases are designed to require minimum maintenance. Bases should be kept clean. Do not let dirt build up on the bases. Never leave bases standing in water. To keep your bases looking their best, you may wish to store them when not in use for an extended period of time.

#### **International Returns:**

If an item is found to be under warranty Shademaker and Jardinico shall only be responsible for ground shipping charges to the location of the product within the continental United States and Canada. Any duties, express, international or special shipping charges are at the expense of the retail dealer or consumer.

#### **Important Restriction for Shademaker and Jardinico products Warranty**

**Service:** Shademaker and Jardinico restricts warranty service products to the country where Shademaker, Jardinico or its authorized retail dealers originally sold the product.

#### **Changes/Cancellations:**

No cancellations, changes, additions or holds will be accepted for an order for which materials have been ordered or produced. Cancellations and/or changes of product or shipping dates on orders must be received in writing within 5 business days of the acknowledgment date. Orders that do not follow these guidelines will be charged a 25% restocking or handling fee. Specially ordered merchandise and custom logo products cannot be cancelled, returned, or refunded. Delivery dates on custom orders are estimated only and may change because of fabric, shortages, production delays, port delays, acts of nature and availability of merchandise.

It is our policy to continuously improve designs, materials and manufacturing methods in order to provide you with the finest products. Therefore, variations in specifications, materials, prices, styles and finishes may be made without notice.

**NO RETURNS ON CUSTOM, VALANCE OR DESIGNER CANOPY STYLE UMBRELLAS.**

**THE SELLER DISCLAIMS ANY IMPLIED WARRANTY OF MERCHANTABILITY.**

Those filing warranty claims will be responsible for all shipping, handling, and freight charges on all claims to Shademaker/Jardinico in Baldwin Park, CA. All warranty claims must be submitted with the original proof of purchase, date of purchase, name of dealer, and the description of the damage. The Shademaker and Jardinico warranty is not transferable. Shademaker and Jardinico reserves the right to repair, replace, and/or redesign any product that is returned under a warranty claim.

For questions, contact Shademaker/Jardinico Customer Service:  
**626-338-8810, [info@shademakerusa.com](mailto:info@shademakerusa.com) or [info@jardinicousa.com](mailto:info@jardinicousa.com)**



**COM Requirement Form** (Customer's Own Material)  
FAX or Email Request to: **888.821.8868** or [order@treasuregarden.com](mailto:order@treasuregarden.com)

Please fill in all fields. Shaded areas to be filled by Treasure Garden.

Company: \_\_\_\_\_  
Contact: \_\_\_\_\_  
Address: \_\_\_\_\_  
City, State, Zip: \_\_\_\_\_  
Phone/Fax: \_\_\_\_\_

**PO#** \_\_\_\_\_  
Customer No.: \_\_\_\_\_  
Written By: \_\_\_\_\_  
Date: \_\_\_\_\_

**FABRIC SHIPPING FROM:**

Name: \_\_\_\_\_  
Phone: \_\_\_\_\_

**SHIP FABRIC TO:** Treasure Garden  
13401 Brooks Drive  
Baldwin Park, CA 91706  
626-814-0168

QTY.	Umbrella Item No.	Fabric No.	Fabric Name	Fabric Mfg.	Fabric Type Awning/Outdoor	Description	Stripes* Yes/No	Repeat Yes/No	Width 46"/54"	Yardage Required	Proceed Yes/No
									in.		
									in.		

**\*NO RAILROAD**

**IMPORTANT:**

- Must submit a **9"x 9"** swatch to ensure fabric can be used for the requested umbrella(s).
- Do not ship fabric until request has been approved. If approved, orders will not be scheduled for production until fabric is received. A revised acknowledgement with anticipated ship date will be sent.
- If the COM fabric is sent directly from an outside source – information regarding your order must be included to match the fabric to your Purchase Order.
- COM fabric received without any reference to a Purchase Order No., may be refused.
- **STRIPED FABRICS MUST BE ORDERED IN PAIRS – NO STRIPES ON RECTANGLE UMBRELLAS OR SHANGHAI COLLAR TILT.** NOTE: For stripes, please include the whole stripe repeat.
- Additional yardage will be requested (as necessary) and/or unused COM returned.

**Please include a copy of this COM Requirement Form with your Purchase Order when submitting.**

NO RETURNS WILL BE ALLOWED – WARRANTY DOES NOT APPLY TO COM FABRIC



13401 Brooks Drive, Baldwin Park, CA 91706  
 Tel. (626) 814-0168 | Fax (626) 814-2001 | Toll Free Fax (888) 821-8868  
 email: order@treasuregarden.com | www.treasuregarden.com

# SALES ORDER FORM

CUSTOMER:  NEW  
 EXISTING

ACCOUNT # \_\_\_\_\_

PO # \_\_\_\_\_

BILL TO: \_\_\_\_\_  
 COMPANY NAME  
 \_\_\_\_\_  
 ADDRESS  
 \_\_\_\_\_  
 CITY STATE ZIP  
 \_\_\_\_\_  
 PHONE  
 \_\_\_\_\_

SHIP TO: \_\_\_\_\_  
 NAME  
 \_\_\_\_\_  
 ADDRESS  
 \_\_\_\_\_  
 CITY STATE ZIP  
 \_\_\_\_\_  
 PHONE (DESTINATION / SHIP TO ADDRESS)  
 \_\_\_\_\_

CHOOSE ONE:  RESIDENTIAL  COMMERCIAL

PHONE		FAX		ORDER TYPE		<input type="checkbox"/> TGEX <input type="checkbox"/> CUSTOM <input type="checkbox"/> EB <input type="checkbox"/> CQS <input type="checkbox"/> SP <input type="checkbox"/> DROP SHIPMENT (\$15 Fee Applies)	
ORDER DATE	COST FACTOR	BUYER	TERMS	SALES PERSON	REQUESTED SHIP DATE	SHIP VIA	WILL CALL

FOB BALDWIN PARK, CA  
 FREIGHT COLLECT  
 PREPAY & ADD

ITEM Complete for ALL product categories.		UMBRELLA FABRIC Complete for all UMBRELLA categories.				
QTY.	ITEM NO.	FABRIC NUMBER(S) DESCRIPTION(S)	DESIGNER COVER <input checked="" type="checkbox"/>	SPECIAL INSTRUCTIONS i.e.: Tag Name, Valance, DWV, etc.	UNIT PRICE	
			<input type="checkbox"/> DC ___			
			<input type="checkbox"/> DC ___			
			<input type="checkbox"/> DC ___			
			<input type="checkbox"/> DC ___			
			<input type="checkbox"/> DC ___			
			<input type="checkbox"/> DC ___			
			<input type="checkbox"/> DC ___			
			<input type="checkbox"/> DC ___			
			<input type="checkbox"/> DC ___			
			<input type="checkbox"/> DC ___			
			<input type="checkbox"/> DC ___			
			<input type="checkbox"/> DC ___			
			<input type="checkbox"/> DC ___			
			<input type="checkbox"/> DC ___			
			<input type="checkbox"/> DC ___			
			<input type="checkbox"/> DC ___			
			<input type="checkbox"/> DC ___			
			<input type="checkbox"/> DC ___			
			<input type="checkbox"/> DC ___			
			<input type="checkbox"/> DC ___			
			<input type="checkbox"/> DC ___			

7823, 7824 AND STRIPED FABRICS NOT AVAILABLE ON SQUARE OR RECTANGLE UMBRELLAS. NO STRIPED FABRICS ON SHANGHAI COLLAR TILT.

- 1. EB = Early Buy Orders from 7/1/21 – 10/1/21 and written at 2022 pricing.  
All EB invoices reflect NET COSTS.
- 2. TGEX = TG EXPRESS QUICK-SHIP PROGRAM
- 3. CQS = CANTILEVER QUICK-SHIP PROGRAM
- 4. CUSTOM = STOCK/NON-STOCK FABRICS
- 5. SP = SPECIAL PROMOTIONS

Written By: \_\_\_\_\_

Date: \_\_\_\_ / \_\_\_\_ / \_\_\_\_

**NO RETURNS ON CUSTOM, VALANCE OR DESIGNER CANOPY STYLE UMBRELLAS.**



**Shown:**

Umbrella:

UM8009

40433 Cast Silver

Umbrella Light:

EVO-09

**Treasure Garden, Inc.**  
13401 Brooks Drive  
Baldwin Park, CA 91706  
p (626) 814-0168  
f (888) 821-8868  
info@treasuregarden.com

**Showroom:**  
Chicago  
1655 Merchandise Mart

[treasuregarden.com](http://treasuregarden.com)